

VEXO®

 CPD



HYDRONIC CLOSED LOOP SYSTEM WATER QUALITY (UK & Republic of Ireland)

Presented by
VEXO

Module 1.

1. Types of Closed Loop Systems relevant to this CPD
2. Objectives of water treatment and specification
3. Types of Corrosion

Module 2.

1. Design considerations for a clean and efficient system
2. Carbon steel Hot or Cold form application – what you need to know
3. Control's philosophy consideration for water quality
4. Plant upgrades and integration to existing secondary circuits

Module 3.

1. Specifying competent pre-commissioning cleaning and commissioning specialists
2. Water Quality and Energy performance/lifecycle correlation
3. Water Quality Specification Resources

Types of Closed-Circuit Systems:

1. Chiller systems.
2. Condenser systems aka ASHP (Air Source Heat Pump) & GSHP (Ground Source Heat Pump) Arrays
3. LPHW (Low Pressure Hot Water) aka LTHW (Low Temperature Hot Water 15°C – 82°C, includes ASHP).
4. MPHW (Medium Pressure Hot Water) and HPHW (High Pressure Hot Water) 95°C Not covered in this presentation.

What is a Hydronic Closed Loop System?

- A circulatory pressurised heat transfer pipework loop - does not (normally) require regular make-up.
- Materials are generally made up of mixed metals, rubber, plastic and fibre washers.
- Heat and cooling source can vary.
- A typical system will lose about <10% water volume per annum.
- Many systems can lose much more e.g., aged District Heating Networks (DHN)
- Make-up can bring new problems (oxygen, minerals, bacteria).

Heating System

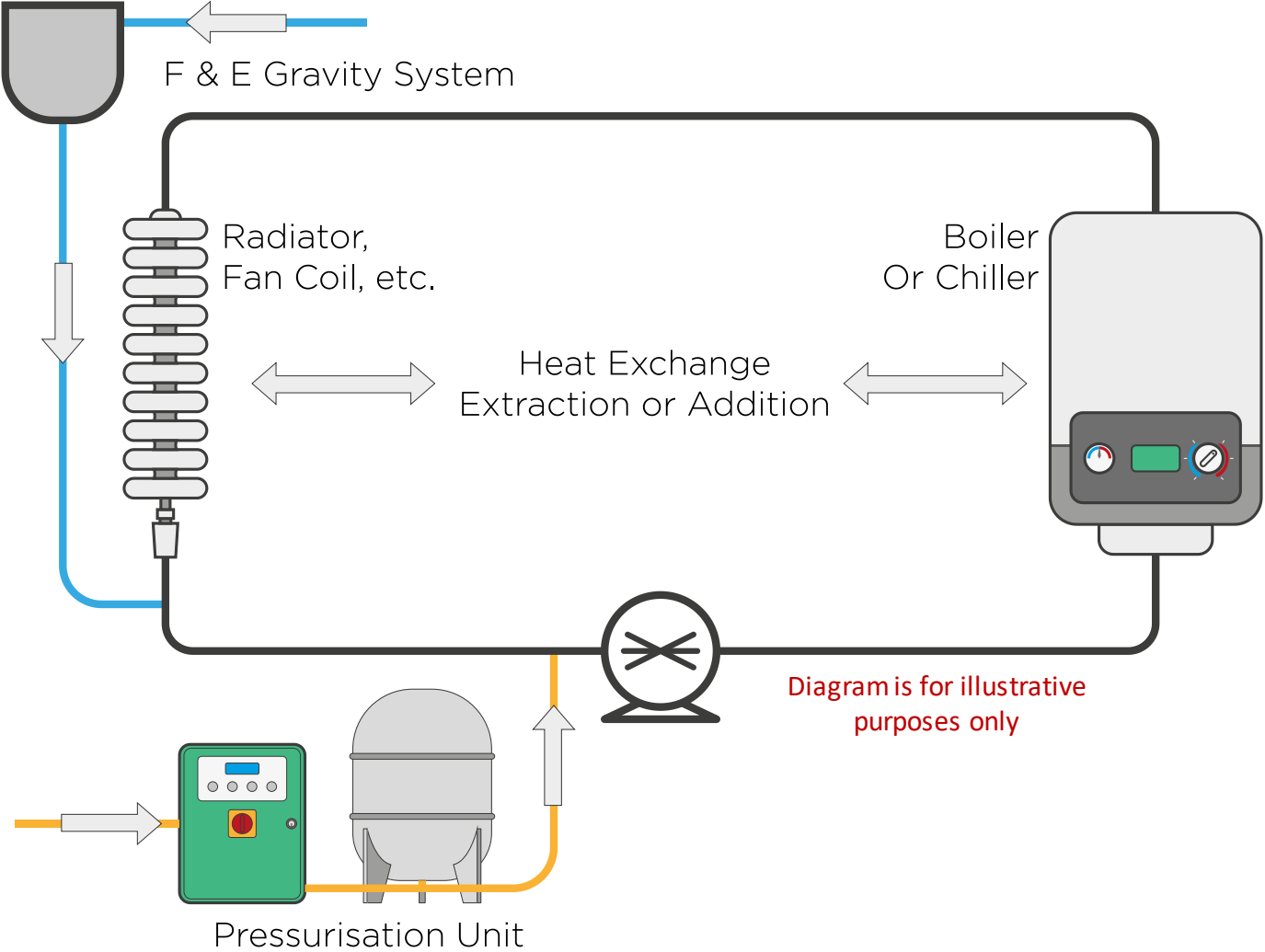

A heating system during heating season essentially acts as a chemical reactor during spring and summer, when stagnant basically acts as an incubator for bacteria.

Weather compensation, low and zero carbon technology operating temperatures put new system designs at greater risk of microbiological influenced corrosion.

Objectives of Water Treatment

When it goes right

- Maintain the system in a clean condition
- Assist in maintaining system efficiency
- Prolong system life
- Avoid conflict & misunderstanding

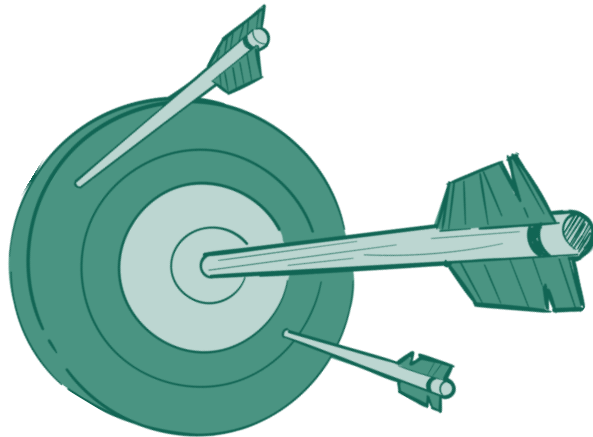

When it goes wrong...

- Asset lifecycle is compromised
- Significant energy efficiency losses
- Unreliable operation and even breakdowns
- Project handover delays owing to non repeatable commissioning readings
- Professional and technology reputation compromised
- Building fabric damage
- Litigation

Objectives of Water Treatment Specification

- Forms of contract
- Programme constraints
- Resource levels
- Method statements (requirements and procedures for acceptance)
- Quality assurance procedures
- Site establishment details
- Compliance with industrial relations protocol
- Bonds, warranties and guarantees

The time and resources needed to accomplish pre-commission cleaning are often underestimated if the designer has not taken advice from the cleaning specialist at an early stage and included realistic estimates in the overall project programme.

For impartiality – Hiring a water treatment expert employed by the main client to oversee the M&E sub-contractor is advised.

Flushing flow rates	Mains Branches
Sizes	Pipes Strainer-basket mesh Valves System volume Dosing pots Filtration/separation equipment Drains Incoming mains water
Locations	Isolating valves Dosing pots Sensitive equipment such as fan coil units, control valves, filters, and strainers Dead-legs and dirt pockets Effluent disposal points System drain points Access to permitted discharge foul drains Quick-fill points Air vents Temporary pipework connections Sampling points Filtration/separation equipment Power supply points (including voltage, capacity and availability during works) Permitted/prohibited access routes for equipment
Drawing reference identifications	Terminal units Branches Valves Flushing valves
Materials	Inventory of materials used in the system (so that compatibility with cleaning and water treatment chemicals can be assessed)
Temperatures & pressures	Full range of system operating temperatures Means of pressurisation Maximum system operating pressure Test pressures of pipework and pressure vessels Relief valve settings
Environmental conditions	Dates when building is open to elements/weathertight/frost protected Dates when floors are non-fitted/partially fitted/fully fitted

BG29/21 Table 1: Example of design information required to flush and chemical clean the system

Closed Circuit Systems



Back to Basics:

Where water is used, we get four problems:



1. Scale Formation

2. Corrosion

3. Microbial Growth

4. Fouling & Sludge

Look Familiar?



NEVER UNDER VALUE A GOOD WATER TREATMENT REGIME AND PLANT SELECTION....IT SAVES ££££ IN THE LONG RUN.

Keeping Perspective

You wouldn't put dirty oil in your engine, so why would you allow dirty water in your closed loop heating or chilled/condenser system!

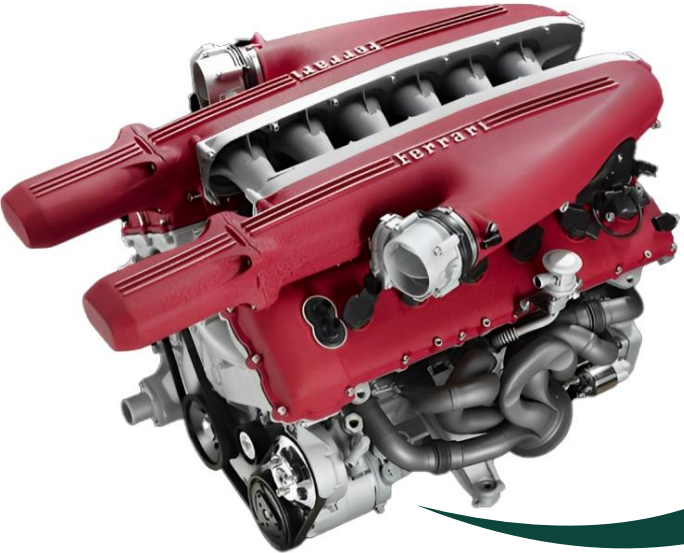
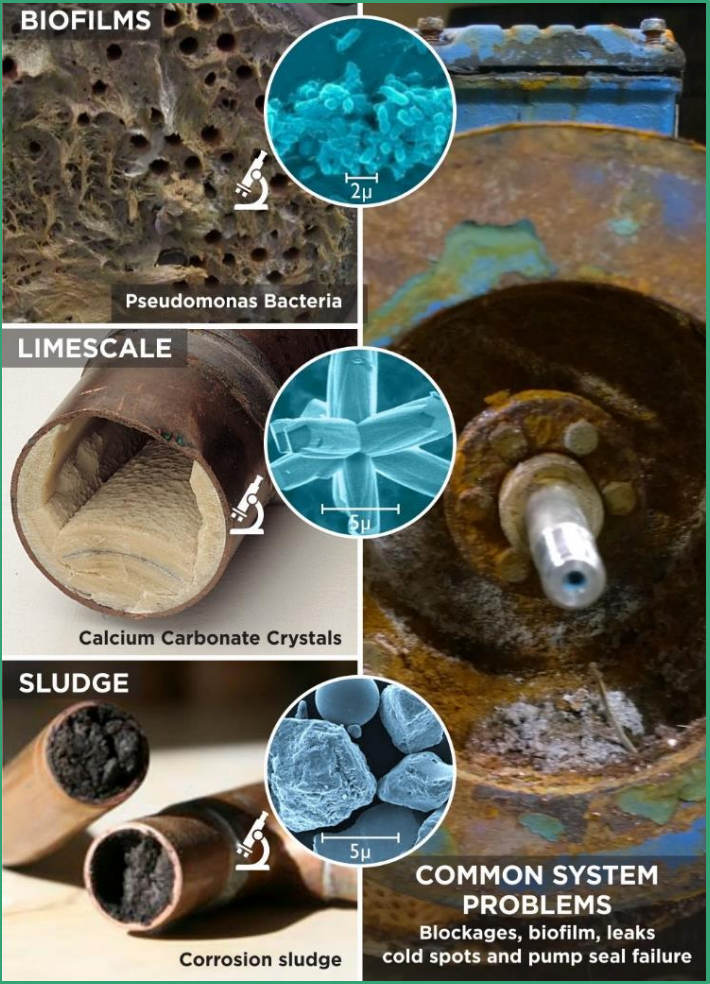

What old/dirty engine oil can do - not much different from closed loop systems.

Closed Circuit Systems

- Scaling - Is the deposition of mainly calcium carbonate or phosphate - hard, crystalline materials on heat exchanger surfaces.
- Interferes with heat transfer and fluid flow. It can detach and block orifices such as thermostatic radiator valves.
- Scaling can be controlled by limiting the water hardness salts (**ion exchange**) using 'water softeners' and/or adding an anti-scaler in a treatment regime (**Inhibitor**).
- Hard water slows corrosion vs soft water due to alkalinity, however it can create under deposit corrosion, erosion corrosion and reduce system efficiency.



Pipework with heavy scale formation

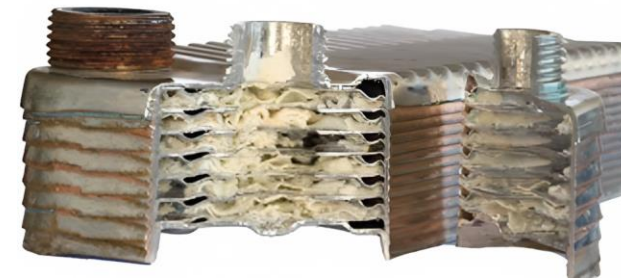

Scaled Heat Exchanger

Water Hardness – UK & ROI

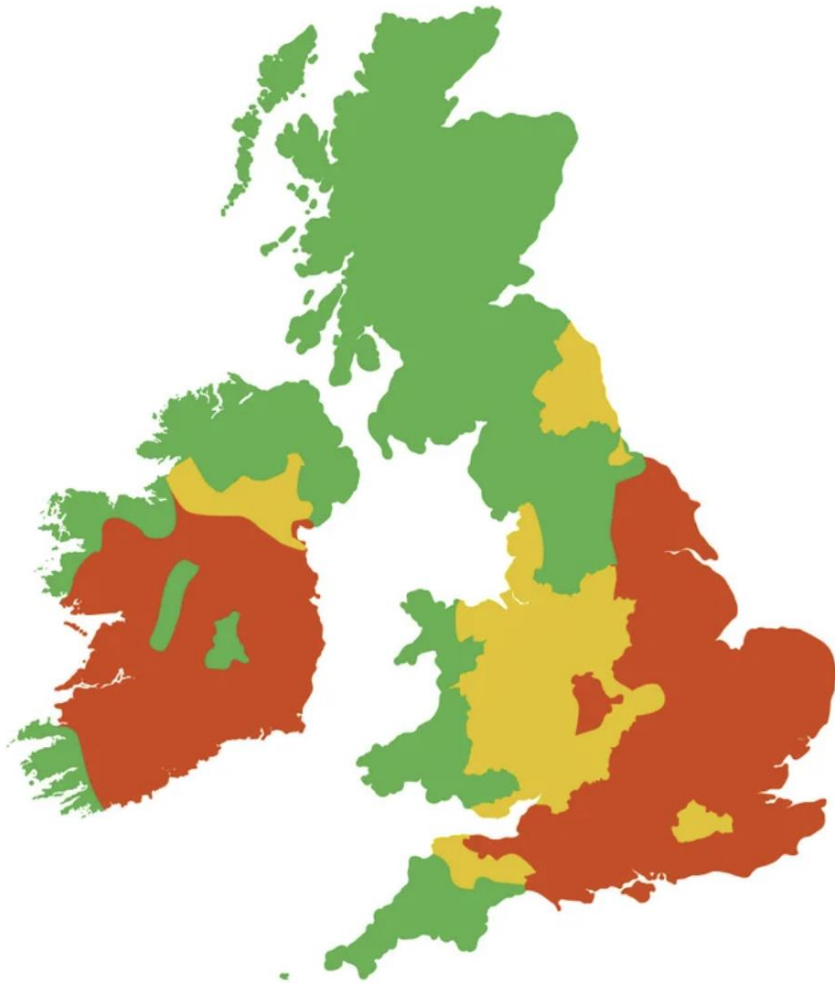

Water Hardness Scale		
Grains/Gal	mg/l & PPM	Classification
Less than 1	Less than 17.1	Soft
1 – 3.5	17.1 – 60	Slightly Hard
3.5 – 7	60 – 120	Moderately Hard
7 – 10	120 – 180	Hard
Over 10	Over 180	Very Hard

Corrosion is a natural process, which converts a refined metal to a more chemically-stable form, such as its **oxide**, **hydroxide**, or **sulphide**.



We cannot stop Corrosion! It can only be slowed and controlled.

What Makes Water More Corrosive?

- Oxygen
- Low pH
- Higher Temperature (all chemical reaction rates increase with temperature)
- Aggressive ions (chloride)
- Debris (sludge, biofilm, etc.)

If we want to **CONTROL** corrosion, we must interfere with the corrosion cell

- Reduce the amount of oxygen (<0.2 ppm)
- Stop the oxygen getting to the metal (film forming Inhibitors)
- Stop the metal going into solution (Inhibitors / sacrificial anodes)

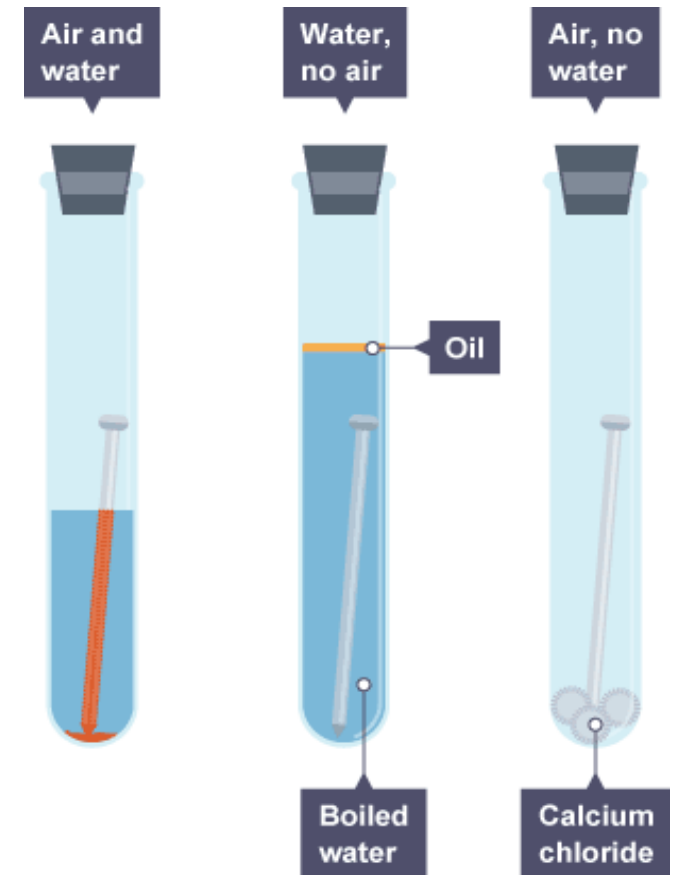

1. Galvanic (Dissimilar Metal) Corrosion

Created when 2 different metals are located together in a corrosive electrolyte (solution), so the environment will be:

- Electrochemically dissimilar metals must be present
- The metals must be in electrical contact with each other
- The metals must be exposed to an electrolyte (solution)

Ensure a suitable sealant (PTFE/Teflon) or coupling is applied so that the metals connected **do not make an electrical connection** (touching each other)



Galvanic Series

Cathode (least active)

- Titanium
- Stainless steel 316 (passive)
- Stainless Steel 304 (passive)
- Yellow brass
- Tungsten
- Tin
- Lead
- Nickel (passive)
- Copper
- Cast iron
- Steel
- Aluminium
- Zinc plating (see galvanization)
- Magnesium

Anode (Most Active)

General (Uniform) & Aluminium Corrosion

General (Uniform) Corrosion

- The most common type of corrosion.
- Uniform corrosion, also known as general corrosion, is the **uniform loss of metal over an entire surface**.
- It is relatively easy to predict using corrosion coupons and by the metals position within the Galvanic Series table.



Aluminium Corrosion

- The Aluminium Oxide layer can be destroyed by copper ions in solution (copper corrosion).
- Elevated pH i.e., > 8.5 – Aluminium require neutral pH Inhibitors (7 -8.2). Incorrect Inhibitor dosing can cause damage and catastrophic failure.
- Then corrosion of the Aluminium can occur quickly.
- Attacks can become highly localised resulting in pits.



Reduce Oxygen – Further Reducing Corrosion Rates

Response of LTHW System Fitted with X-POT Unit to Trapped Air

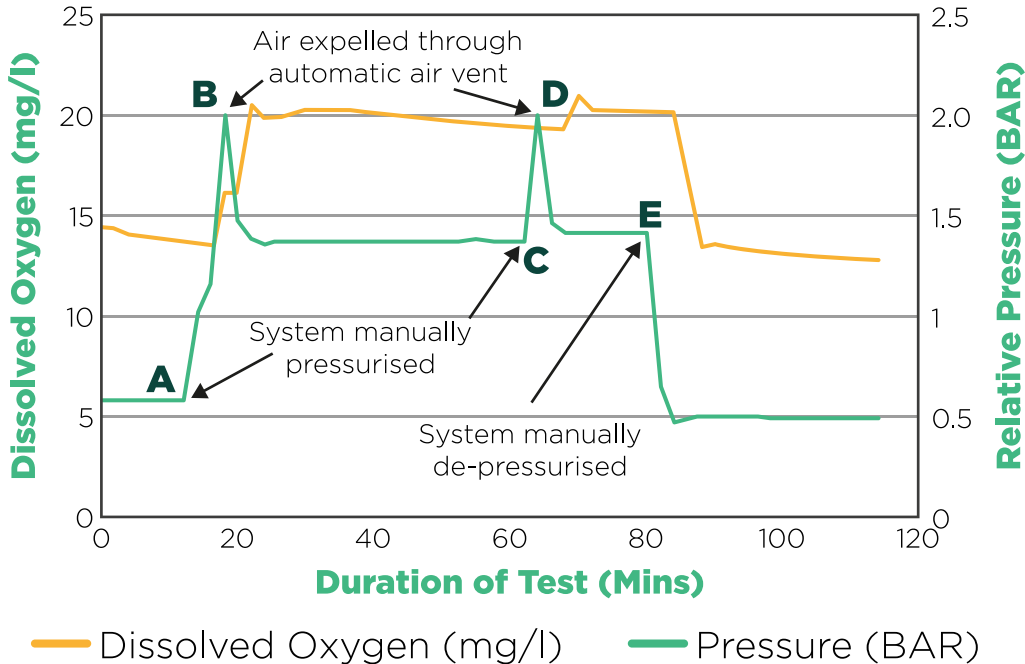

Source: Hevasure Whitepaper (31st March 2016)

The Patented VEXO X-POT works as a dirt and air separator, side stream filter, magnet filter and dosing pot. Acknowledged by BSRIA.

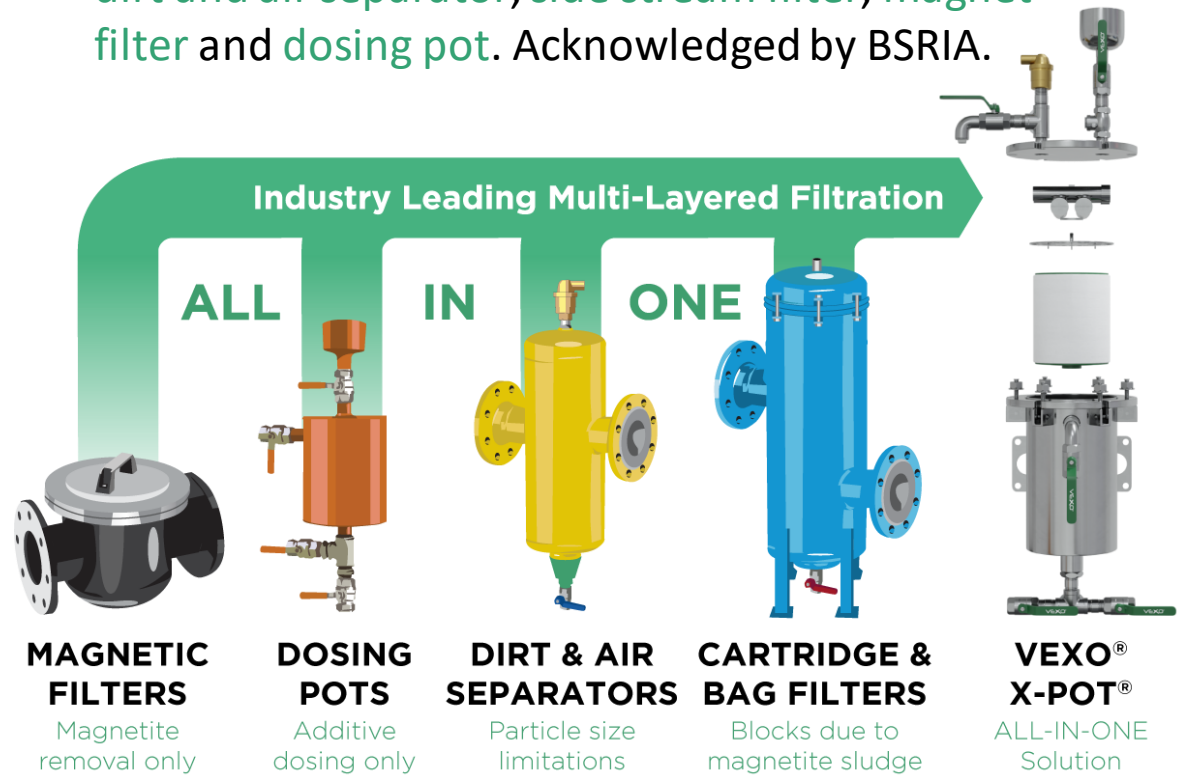

Pitting & Under Deposit Corrosion

Pitting Corrosion

- A small hole or pit forms in the metal surface, usually the result of inconsistent Inhibitor film formation, or debris deposit at that location.
- This area becomes anodic, whilst the remainder becomes cathodic.
- Clean/smooth surfaces (free of debris and biofilm) and a consistent level of inhibitor mitigate pitting.



Under Deposit Corrosion

- A deposit over a bare unprotected metal spot worsens and accelerates the corrosion.
- The deposit restricts the free access of oxygen [air] under the deposit and creates Differential Aeration corrosion cells which multiplies the corrosion rate.
- Anaerobic bacteria (Sulphate-reducing bacteria aka SRB's) can survive beneath the deposit and produce acids that accelerate corrosion



Crevice Corrosion

Crevice Corrosion

Crevice corrosion is a particular form of localised corrosion which occurs in narrow gaps. The crevice corrosion mechanism includes four steps, depletion of oxygen inside the crevice by its consumption in a cathodic reaction that eventually converts the metal inside the crevice to an anode.

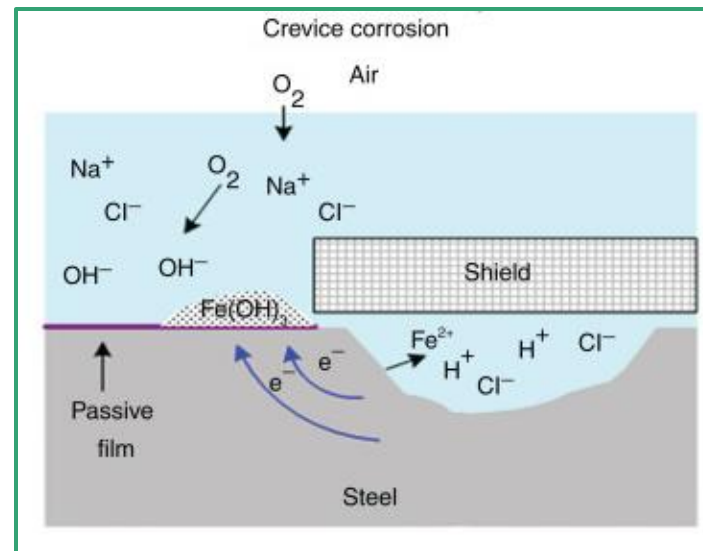

Erosion Corrosion

Erosion Corrosion

A result of excessive flow or high levels of suspended solids. Excessive flow also strips the protective Inhibitor film layer from the pipe wall surface.

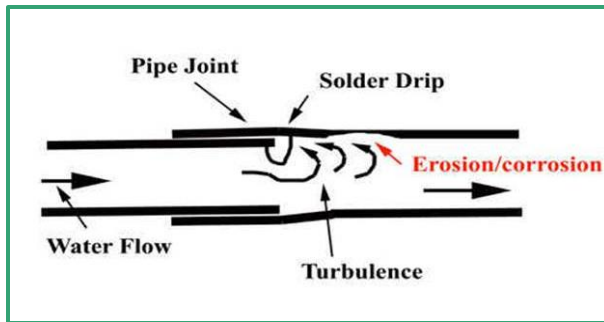

Cavitation Corrosion

A form of erosion corrosion caused by the rapid formation and collapse of vapour bubbles during a change in fluid pressure in a solution adjacent to a metal surface.



Stress Corrosion Cracking (SCC)

Stress Corrosion Cracking

- Growth of crack formation in a corrosive environment.
- It can lead to unexpected sudden failure of normally ductile metals subjected to a tensile stress, especially at elevated temperature.
- SCC is highly chemically specific in that certain alloys are likely to undergo SCC only when exposed to a small number of chemical environments.
- Poor quality brass (non-dezincification resistant or non-DZR in short) and stainless steel in hydronic closed loop systems are typically common SCC material failures experienced within commercial/Industrial applications.

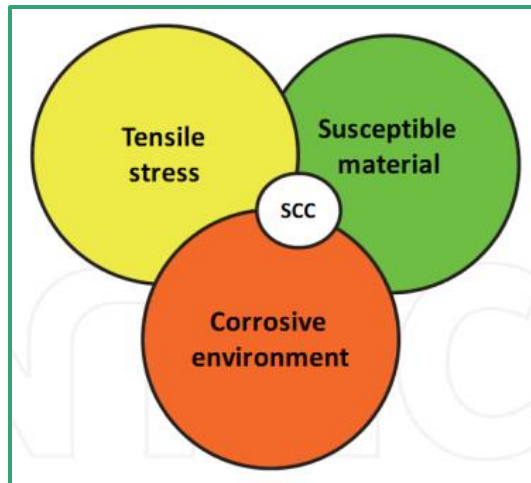

Conditions necessary for SCC to appear



Stress corrosion cracking initiating from pit in austenitic stainless steel



Stress corrosion cracking in brass fitting

Microbiological Influenced Corrosion (MIC)

Direct MIC

- Action of bacteria such as sulphate reducing bacteria (SRB's) underneath biofilm – anaerobic respiration, utilising sulphate as a terminal electron acceptor.
- Converts sulphate to hydrogen sulphide (egg smell and acidic).
- Production of biofilm occluding the pipe surface.

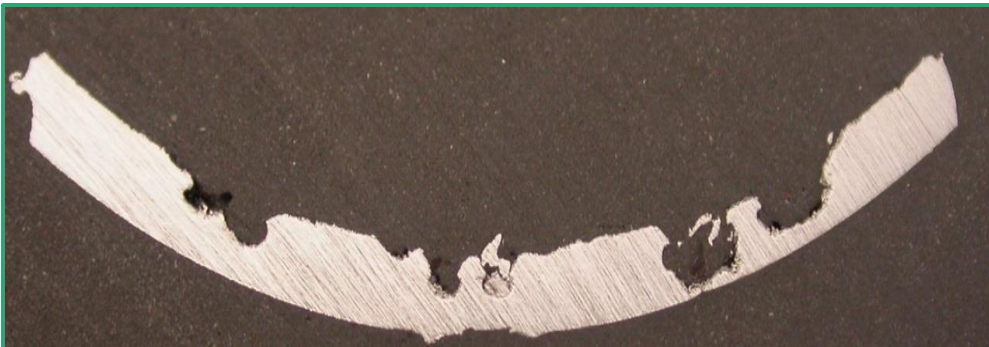

Cross section of thin wall carbon steel

Indirect MIC

- Breakdown of inhibitor components by bacteria e.g. Nitrite Reducing Bacteria (NRB)



GSHP system - Biofilm chemically removed and 'captured' by the X-POT cartridge filter

Glycol Concentration Vs Bacterial

THE EFFECTS OF GLYCOL ON BACTERIAL ACTIVITY WITHIN HEAT TRANSFER SYSTEMS

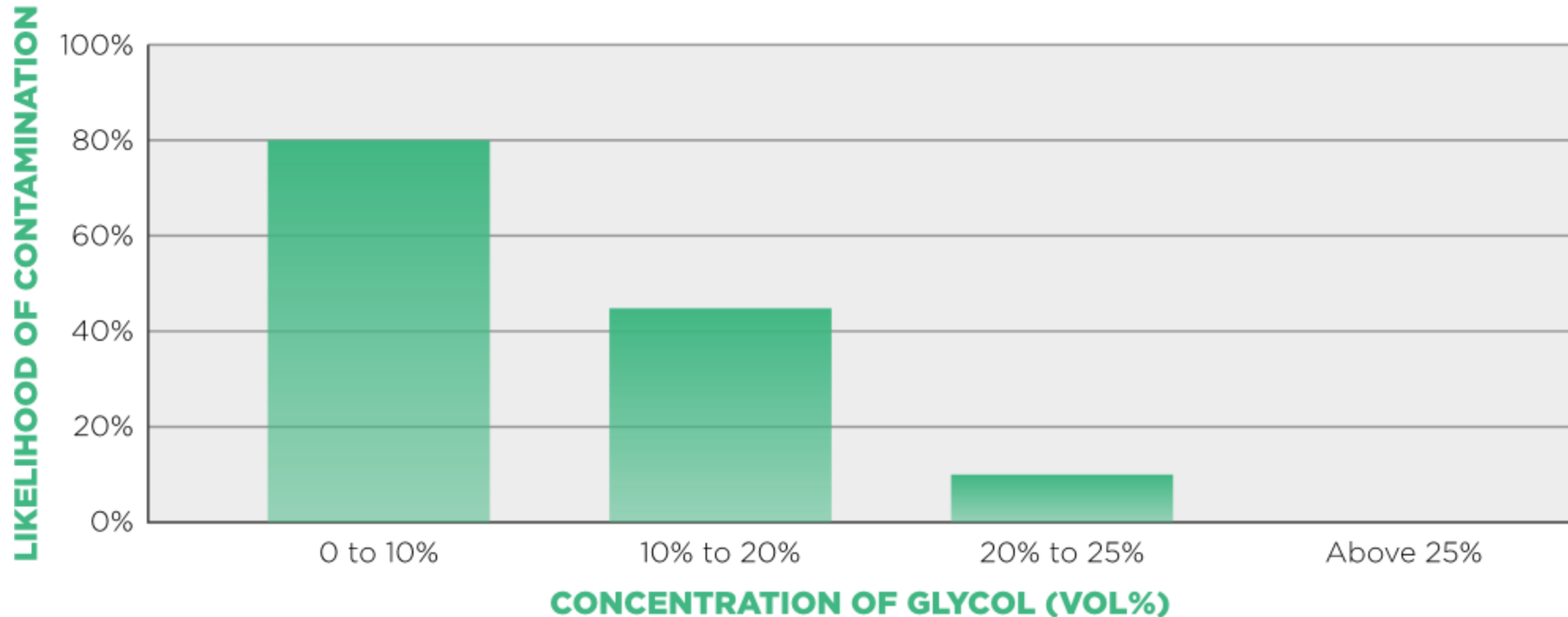

Module 2 – Design Considerations for a Clean & Efficient System

BSRIA BG29/2021 6th Edition ‘Design Considerations’

2.2.1 General – ‘The designer should address the requirements for system cleaning at an early stage in the design of the system’.

‘A system that is easy to clean will probably be easier to commission, more energy efficient and more durable than one that is not. The designer should therefore aim to assess:

1. What design features (permanent and temporary) need to be incorporated to facilitate the cleaning process and on-going water treatment?
2. What design features need to be avoided (or bypassed) to facilitate the cleaning process?
3. Which methods of cleaning are most appropriate for the system?
4. Whether chemical cleaning is important to the successful operation of the system?

It is suggested that the designer consult a suitably qualified and experienced cleaning specialist at an early stage in the project to review and comment on the proposed design so that the assembled system is amenable to successful pre-commission cleaning using the methodologies explained in this guide.

Typical Stages of a Clean

A typical chemical cleaning programme is likely to include some, or all, of the following procedures:

1. Dynamic flushing to remove loose solids (velocity is critical).
2. Biocide wash (for systems at risk from bacteria) – Including fan coils, chillers etc that may have been wet tested by the the Original Equipment Manufacturer (OEM)
3. Removal of surface oxides (for systems with mild steel components).
4. Effluent disposal/final flushing.
5. Corrosion inhibitor and biocide dosing – followed by back flushing.

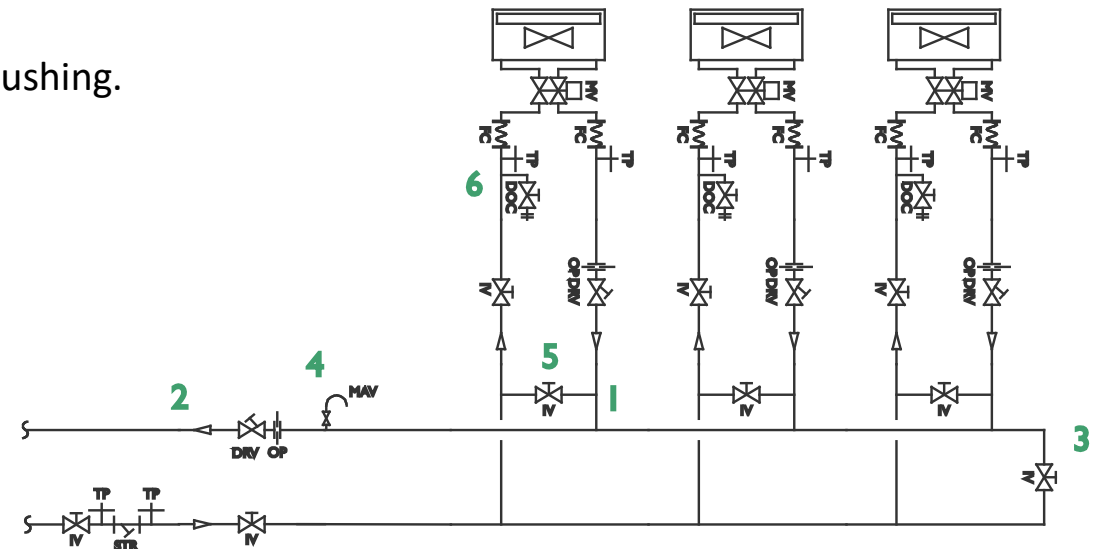
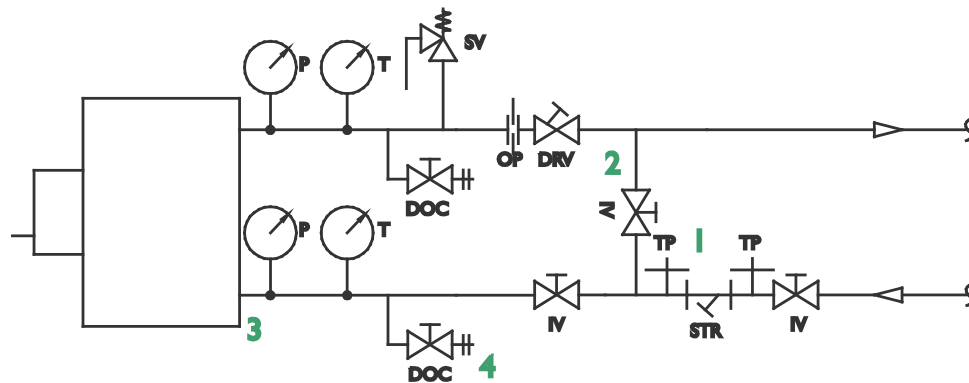

Ensure provision for line size flushing by-passes to remove construction debris and protect terminal units

Design for Water Quality

- No dead-legs
- Line size flushing by-passes
- Circulation of all areas for **at least one hour per day**
- Treatment starts before filling
 - ✓ Make sure first fill water is suitable quality
 - ✓ Add biocide and inhibitor with first fill water
- Flow rates do not encourage deposition or erosion
- Correct pressure vessel and pressure calculations
- Strainers, Dirt and Air Separation, filtration at 5 micron (minimum) with PD alarm
- Correctly sized vacuum degassers (Chilled/Condenser)
- Dosing Pots on system volumes <1500L
- Plastic pipework must be oxygen barriered and suitable for the application
- Dirt pockets at risers
- Adequate vents
- Sampling points
- Future fitout by-passes and isolations
- Flushing valves
- Metering stations at branches
- **Design the whole programme accordingly**

BSRIA Minimum Flushing Velocities to Clean Pipework - Is the Design Amenable?

Nominal pipe size (mm)	Internal diameter (mm)	Flushing velocity (m/s)	Flushing flow rate (l/s)	Reynolds number
15	16.1	0.96	0.20	6300
20	21.7	1.00	0.37	8800
25	27.3	1.03	0.60	11,300
32	36.0	1.06	1.08	14,900
40	41.9	1.08	1.49	19,000
50	53.2	1.11	2.47	24,400
65	68.9	1.15	4.29	32,800
80	80.9	1.17	6.01	41,100
100	105.3	1.21	10.5	53,100
125	129.7	1.24	16.4	68,000
150	155.1	1.26	23.8	83,000
200	206.5	1.31	43.9	115,000
250	260.4	1.35	71.9	148,100
300	309.7	1.37	103.2	180,400

BSRIA Minimum Flushing Velocities to Clean Pipework - Is the Design Amenable?

System size	Representative sample points
< 3000 litres and < 2 terminal units	1 sample location in main plant area
< 3000 litres and < 25 terminal units	1 sample location in main plant area + 1 remote location
≥ 3000 litres or ≥ 25 terminal units	1 sample location in main plant area + 1 remote location plus additional sample locations to be agreed with cleaning specialist

BSRIA BG29/2021 6th Edition.

Table 10: Scope of sampling between filling/pressure testing and pre-commission cleaning (every 4 weeks) for each system.

The recommended frequency of sampling between pre-commission cleaning and practical completion is every 2 weeks with sample numbers and locations as shown in Table 11.

System size	Representative sample points
< 3000 litres and < 2 terminal units	1 sample location in main plant area
< 3000 litres and < 25 terminal units	1 sample location in main plant area + 2 remote locations
3000 – 8000 litres and 25 - 80 terminal units	1 sample location in main plant area + 3 remote locations
8000 – 20,000 litres and 80 - 250 terminal units	1 sample location in main plant area + 4 remote locations
20,000 – 40,000 litres and 250 – 500 terminal units	1 sample location in main plant area + 5 remote locations
> 40,000 litres and > 500 terminal units	1 sample location in main plant area + (Number of terminal units / 500) * 5

Table 11: Minimum scope of sampling immediately post clean and up to practical completion (every 2 weeks) for each system.



Remote monitoring technology is available, providing an on-line dashboard and alerts.

VEXO Product Incorporation (Y-MAG)

Incorporating innovating products, such as the patented **VEXO/BOSS Y-MAG** – Provides enhanced protection for lateral pipework runs and terminal units. Cleaner mesh baskets = greater pump efficiency.

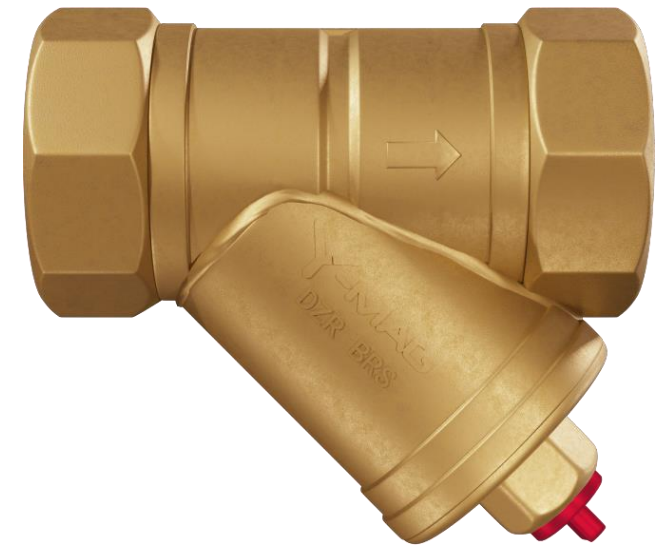
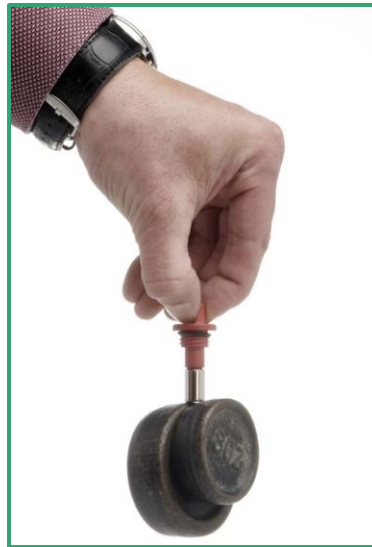
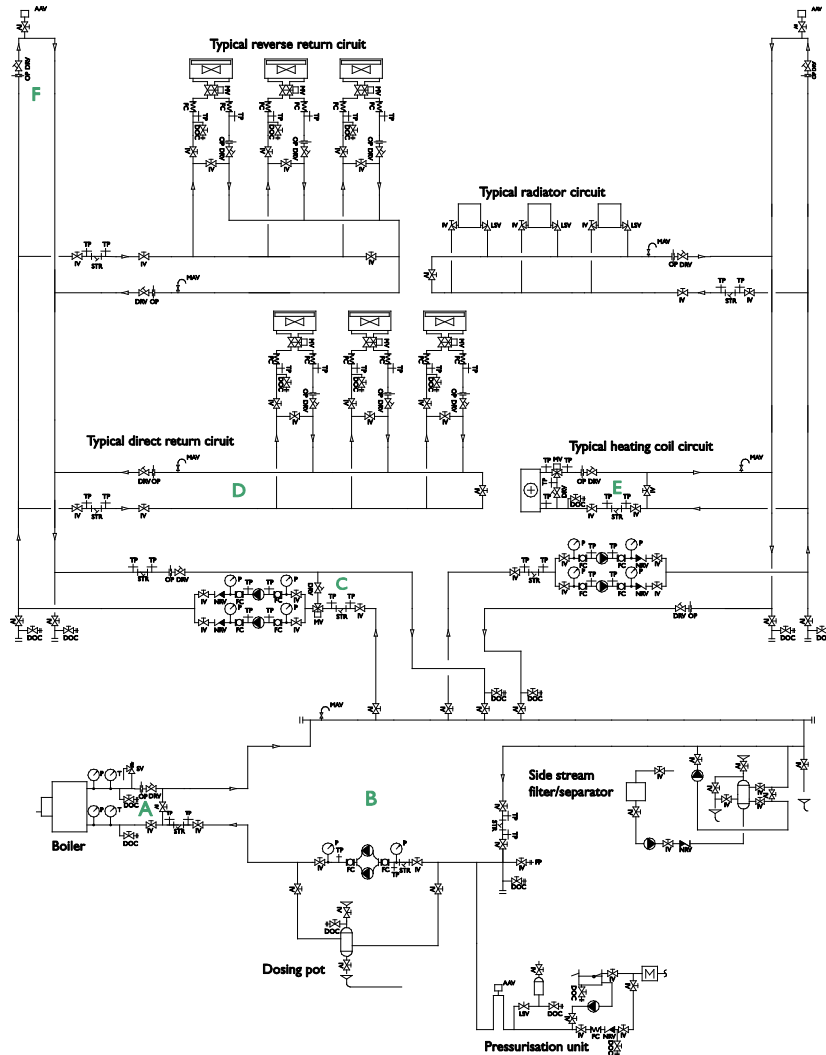

Circulation

- Unless water circulates to all parts of the system, treatment will not reach all parts of the system.
- If water is not moving solids will settle.
- Temporary flushing bypasses should have been removed.
- Dosing pots should remain open to the system to avoid stagnation. X-POT is a retrofit all-in-one solution.

Why do you need Biocides in Closed circuit systems?

1. To prevent the build-up of biofilm:
Biofilm prevents heat transfer, blocks pipe-work & allows under deposit corrosion to occur.
2. Biofilm protects underlying bacteria from biocides:
When biocides become depleted, the system will become re-contaminated from the bacteria in the biofilm.
3. To prevent breakdown of some inhibitors:
Some bacteria break down Nitrite to Nitrate. Nitrate based inhibitors are particularly vulnerable.

Bio dispersants are required to strip biofilm (VEXO X-PO35) to expose the bacteria to a biocide (VEXO X-PO80).

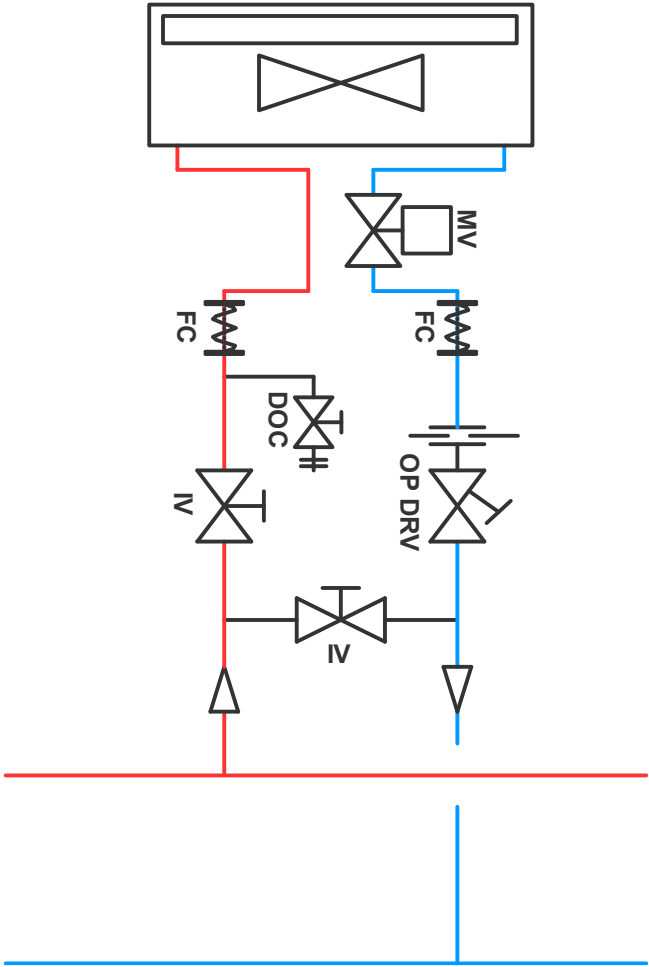

Inhibitor Effectiveness



Inhibitors are used to control scale and corrosion.

- An inhibitor must be in direct **contact with the metal surface** in order to ensure optimal corrosion protection.
- Pipework containing biofilm, scale, corrosion deposits, general debris before inhibitor is added **will not get optimal protection from the inhibitor**.
- The **target values** for inhibitor concentration **are MINIMUM's**, below these levels optimal corrosion / scale protection will not be achieved.
- Keep system water clean, filtered (5 micron) and treated with inhibitor and (as required) biocide.

Antifreeze

Mono-Ethylene Glycol - Used in CHW.

Mono-Propylene Glycol - Suitable for use in food factories / pharmaceutical manufacturers.

Used in LTHW & Residential systems.

Inhibited Glycol also available.

Use a refractometer to test concentration for MEG and MPG.



Carbon Steel Hot or Cold Form Application - What You Need to Know

- Knowing how a tube was made is very important, as different hot and cold tube manufacturing routes result in different mechanical and performance properties.
- Hot Part-2 products are technically superior and can be used at both low and elevated temperatures.
- Cold-formed Part-1 tubes are only suitable for ambient temperature (max 50°C) and are no longer suitable in pressure applications under the PED (Pressure Equipment Directive). Therefore, closed loop pressurised hydronic systems should specify hot form for compliance and mitigation of litigation.

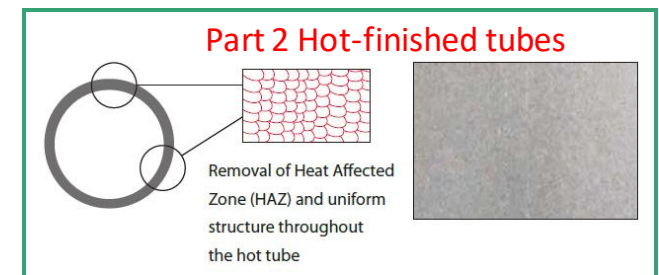
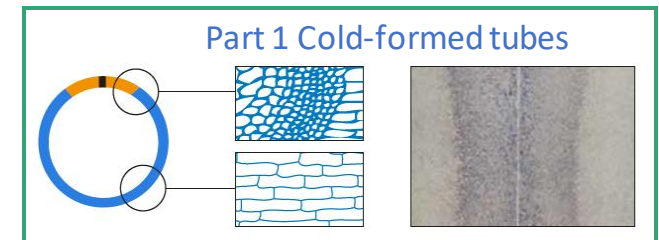
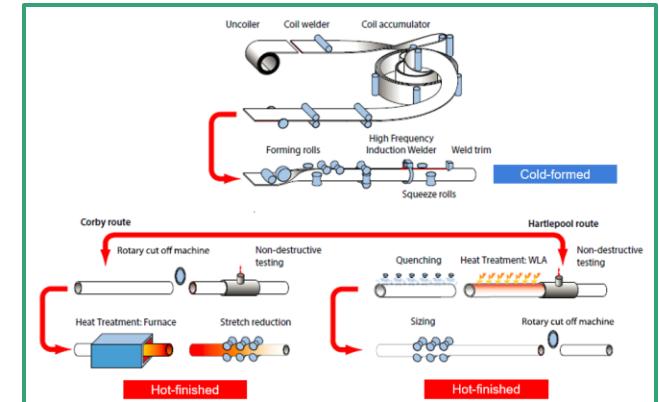

Source: Tata Steel

Pipework Specifications

Carbon steel tubes are typically multi-standard, i.e. supplied to more than one standard to clearly show their Technical Delivery Conditions (how they were made, application suitability etc).

COLD welded:
BS EN10255/10217-1

HOT welded:
BS EN10255/10217-2

- BS EN10255 defines sizes, testing, CPR CE (UKCA) marking etc.
- BS EN10217 shows it's a HFW (High Frequency Welded) tube.
- Part 1 is typically COLD made and for ambient temperatures only.
- Part 2 is HOT made and suitable for elevated temperature use.

Top 10 key points

	Hot	Cold
Is the HAZ (Heat Affected Zone) removed	Yes	No
Is the weld seam stress free as a result of heat treatment	Yes	No
Is the tube more ductile, allowing for better bending, threading etc.	Yes	No
Can I be sure of consistent mechanical properties	Yes	No
Can I satisfy higher application temperatures above 50°C	Yes	No
Is the tube also tested for lower temperature applications	Yes	No
Are mechanical properties consistent when re-welding the tube	Yes	No
Does the tube satisfy the essential requirements of the PED	Yes	No
Is the tube UK manufactured and fully traceable	Yes	No
Is the tube more resistance to corrosion	Yes	No

Source: Tata Steel

Control Philosophy Consideration for Water Quality

As the world looks to transition to low carbon and zero carbon heating, operating at lower temperature and higher flow rates - this provides a challenge ahead.

Optimizing existing heating systems using smart technology such as IoT, weather compensation, smart pumps and internal OEM controls using volt free contacts now change the way systems operate.

This change leads to:

1. Sporadic low and high flow rates.
2. Lower water temperatures when weather compensating .
3. ASHP & GSHP operating at max either 35°C up to 50°C flow.
4. Periods of stagnation.
5. Higher volumes of stagnant water (buffer vessels).
6. Make up water provided untreated from a Pressurization Unit (PU) – bacteria loaded water is injected when make-up required.

Although at lower temperatures chemical reactions slow down, the new challenge will be managing microbiological proliferation which can manifest as accelerated corrosion, inhibitor losses, gassing and poor flow/efficiency.

Control Philosophy Consideration for Water Quality

To manage water quality both chemically and microbiologically, greater emphasis is required on:

1. Circulation (all parts of the system for 1 hr/24 hrs minimum).
2. Pressure.
3. Make Up Water disinfection and make up water meter analysis.
4. Minimum fluid velocities / Flow Rates (>0.5m/s)
5. Filtration and DP alarm notification.
6. Treatment of biocides or use of thermal pasteurization.
7. Water sampling (on-site and remote).
8. Energy performance trends.

The system BMS specification should ideally be set to take the above into consideration.

[VEXO Portsmouth City Council case study details](#) 25% gas saving achieved using VEXO S-BMS

Plant Upgrades & Integration to Existing Secondary Circuits



50 Year old system
(No Inhibitor)



Same system 1-hour
after adding Inhibitor

Without filtration these turbid suspended particles will create erosion corrosion and prevent effective Inhibitor film laying down to offer protection.

Previously considered old “clean” systems can soon be discovered to have fouling when adding chemicals (Inhibitor).

Existing Systems Can Be Found to Have Fouling - This Can Affect New Plants



Magnets from X-POT Compact unit -
post 1-hour from dosing VEXO X-
PO10 Inhibitor



Same system **12 days later**



X-POT Compact 20-micron Filter

Restoring aged systems will increase efficiency, reliability and lifecycle

A Passive Long Term Clean is More Effective for Aged Systems Before Upgrading



Carry out initial validation sampling

Install X-POT & PD-Monitor 3 months prior to plant upgrade/replacement

Run for 1-month, magnets only

Dose VEXO Non-Flush Additives

Monitor & filter down from 50 micron until 5 micron is achieved

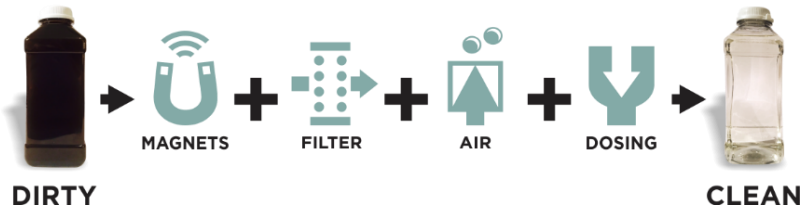

Test & Dose system with Inhibitor & Biocide then circulate prior to isolation & plant upgrade – followed by sampling the system

50-Year-Old System Performance Restored Using X-POT & VEXO X-PO10 Energy Saving Inhibitor



X-POT Magnet Grate post cleaning & new filter ready (15 minute process)

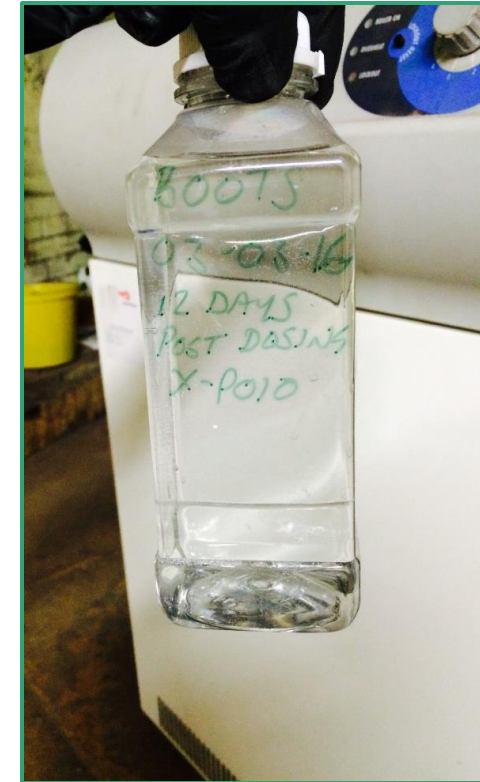

Final system water after 12 days

X-POTs Retrofitted in Place of Aged Existing Dosing Pots – Tangible Results

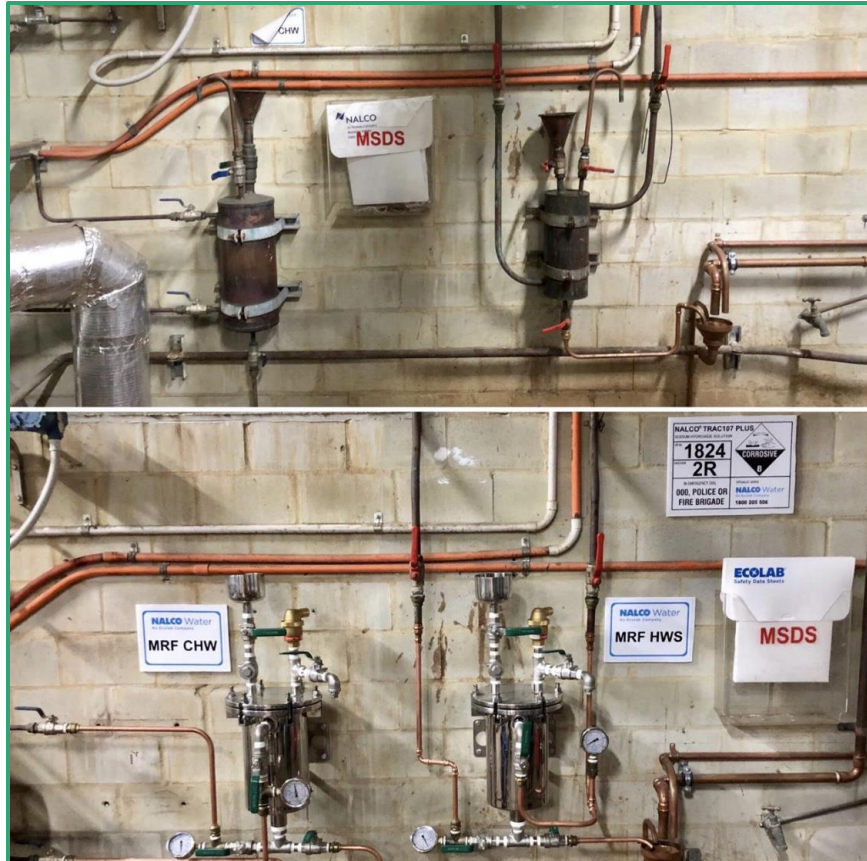

Module 3 – Specifying Competent Pre-Commissioning Cleaning & Commissioning Specialists

How do you ensure you specify a 'competent' specialist...

Let's keep it simple – within the specification we suggest you state:



1. *'The cleaning specialist and subsequent FM service providers water treatment specialist shall be registered members with the closed system control association (CSCA)'.*
2. *All activities shall include the necessary labour, equipment, technical resource materials and sundries for the pre-commissioning cleaning activity undertaken in accordance with Industry best practice as detailed in BSRIA standards BG29/2021 6th Edition & BSRIA BG50/2021.*
3. *Water sampling activities shall be in accordance with BS 8552:2015*
4. *Lead technicians must have a minimum 3 years experience of commercial and industrial hydronic closed loop systems, appropriate evidence of training and CSCS supervisor's card.*
5. *Method Statements & Risk Assessments (RAMS) should demonstrate a clear and concise understanding of the system particulars, materials and appropriate treatment additives.*
6. *Detailed highlighted drawings of the batched velocity flushing sequence, sampling and testing locations to be detailed , along with temporary make-up water and effluent drain location.*

Water Quality & Energy Performance/Lifecycle Correlation

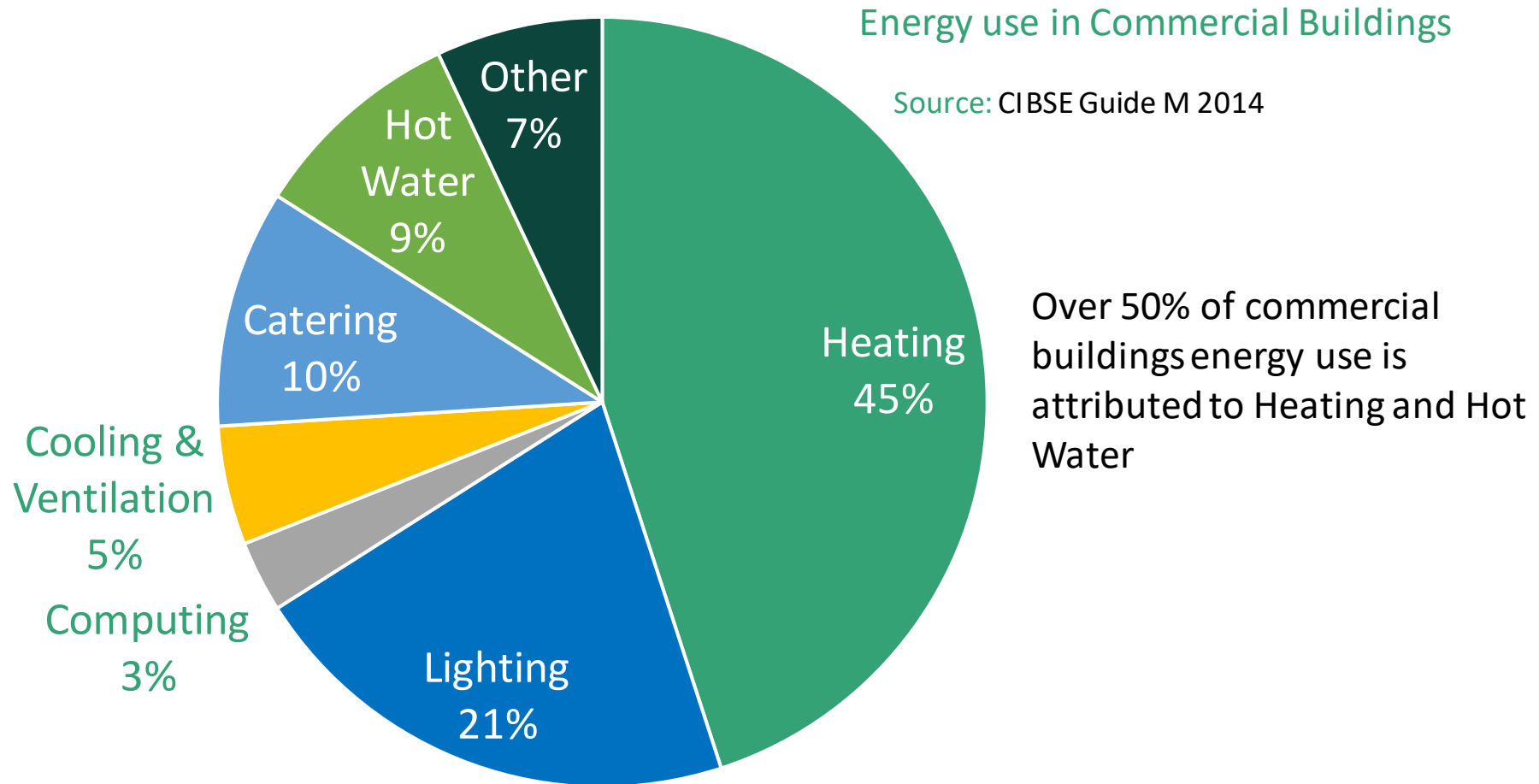

Effect of Biofilm on Heat Transfer Efficiency

Source – Aquaristech.com (Australia)

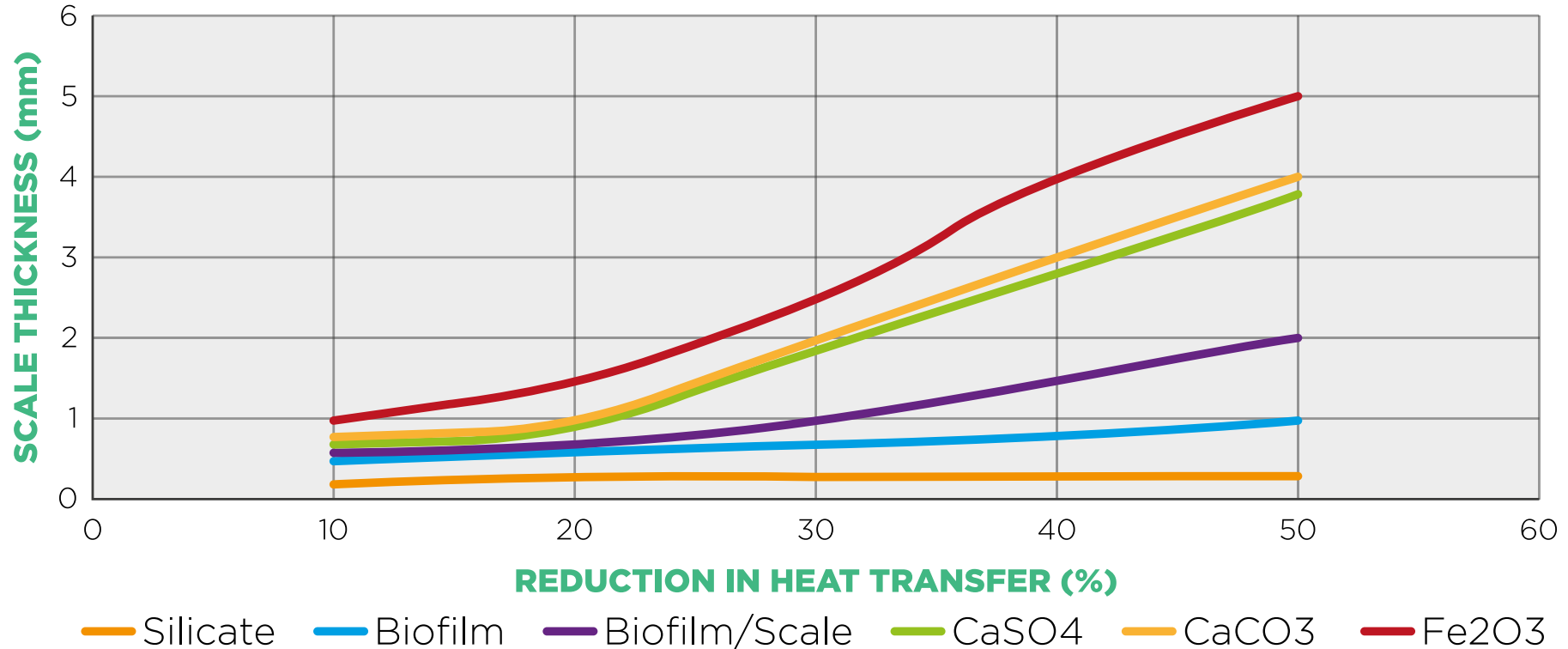

Biofilm is the second greatest insulator after silicate scale – even greater than Calcium scale and Iron oxide

Incorrect Heat Measurement



Incorrect heat measurement could lead to under payment and hence loss of revenue for the RHI participants.

Water Quality - Maintaining good water quality is important for all components of a heating system. Where water quality is poor, accelerated wear and corrosion are likely to lead to increased maintenance and reduced component life.

Dirt – Indications are that dirt or other deposits can cause very large measurement errors of over 10%... Other contaminants that could form deposits or alter water properties include Magnetite, a product of corrosion and therefore an indication of poor water quality.

Size Filtration Accurately

VE^XO[®]

X-POT Range Overview



X-POT Compact

630_h x 285_w x 325_d

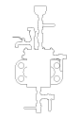

4 Bar



34,560L^{sv}



Down to 0.5um



X-POT 6

915_h x 460_w x 305_d



7 Bar



86,400L^{sv}



Down to 0.5um



X-POT XP

1460_h x 490_w x 730_d



16 Bar



302,400L^{sv}



Down to 1um



X-POT XXP

1460_h x 490_w x 730_d



30 Bar



302,400L^{sv}



Down to 1um



X-POT HFHP

1750_h x 995_w x 730_d



10/30 Bar



2,592,000L^{sv}



Down to 1um



Industry Standard

BSRIA BG29/21 '6th Edition' & BSRIA BG50/2021 recommends '5% of the circulating water should be diverted through the side stream filter' and 'filters should be easily maintainable & fitted with a differential pressure indicator or BMS sensor'.



Compliance Pack
With PICV valve and BMS
compatible pressure
differential monitor.

BSRIA BG29/21 '6th Edition' Pre-commission 'Cleaning of Pipe Work Systems' recommends a 5 micron filtration rate. The X-POT[®] utilizes industry leading 0.5 micron Cartridge Filters (10x Finer) and 1 micron Bag Filters (5x Finer), capturing more debris resulting in greater energy savings and prolonged life cycle realisation.



Bag Filter
1 Micron
5 Micron
20 Micron
50 Micron



Cartridge Filter
0.5 Micron
5 Micron
20 Micron
50 Micron

Frequency of Sampling

BSRIA BG50/2021 states the frequency and extent of routine monitoring will depend on the operating characteristics, susceptibility to disturbance, and operational importance of the system and can vary through the life of the system installation.

The typical frequency of routine monitoring for heating and cooling systems in non-domestic buildings in normal operation should be every two weeks in the following circumstances:

- For the first two months after handover (four sets of results)
- During and/or after remedial cleaning procedures
- After any uncontrolled water losses

Sampling should be every month in the following circumstances:

- When there is evidence of deteriorating water quality
- When there is evidence of water losses
- During periods when external contractors such as fit-out contractors are present

Three-monthly monitoring is only appropriate when the system has a good record of water quality with minimal water losses and a responsive and knowledgeable maintenance team on site. Detailed guidance is provided in the British Standard BS8552:2012.



Sample from 2-year-old LTHW Heating System, before and after water treatment

Energy Efficiency Restoration Using VEXO X-POT Mechanical Filtration & VEXO X-PO10 Inhibitor Peer Reviewed White Papers

“The X-POT Side Stream Filtration system reduced energy consumption by 3.5% within the first 7 days of use.”

Johnathan Cripps, MSc Dissertation:
Low Energy Building Services Engineering (Effects of Corrosion on Heat Transfer Efficiency within a Heating System
Loughborough University



“Results suggest gas bill reductions of up to 10% are possible whilst prolonging the life cycle of existing heating systems.”

Dr Rayner Mayer,
Trials of VEXO X-POT10 Inhibitor Sciotech Projects
Loughborough University



Investigating the Impact of Mechanical Filtration in Restoring The Energy Performance of Closed Loop Heating Hydronic Systems

AMR SULIMAN BSC(HONS) MSC

Building Energy Research Group, School of Architecture Building and Civil Engineering, Loughborough University, UK

a.suliman2@lboro.ac.uk

DARREN WILKINSON

Managing Director, VEXO International VEXO International

darren.wilkinson@vexoint.com

MAHROO EFTEKHARI CENG DPHIL FCIBSE MASHRAE MINSTR SFHEA

Course Director MSc Low Energy Building Services Engineering

School of Architecture Building and Civil Engineering, Loughborough University, UK

m.m.eftekhari@lboro.ac.uk

VANDA DIMITRIOU MENG MSC PHD FHEA

Building Energy Research Group, School of Architecture Building and Civil Engineering, Loughborough University, UK

v.dimitriou@lboro.ac.uk

Peer reviewed and approved by CIBSE for technical presentation at CIBSE & ASHRAE Technical Symposium

University of Strathclyde, Glasgow 20th - 21st April 2023

3.1 Results for Pump Power Consumption

- The results also show that when the system is dirty and unfiltered the power consumption of the pump increases by between 12% and up to 23% with an average of 19%.
- When the filter is deployed to clean the system, it can be seen instantaneously the the power consumption starts to fall and is **closely restored to the clean value**.
- The filter was successfully able to **restore** the power consumption of the pump by 83.5% (minimum) and in some cases restoring the system performance beyond its performance when it was clean before the magnetite was added.

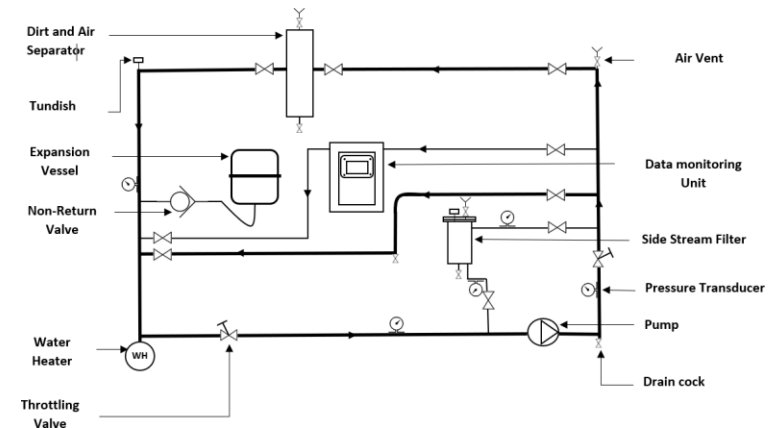
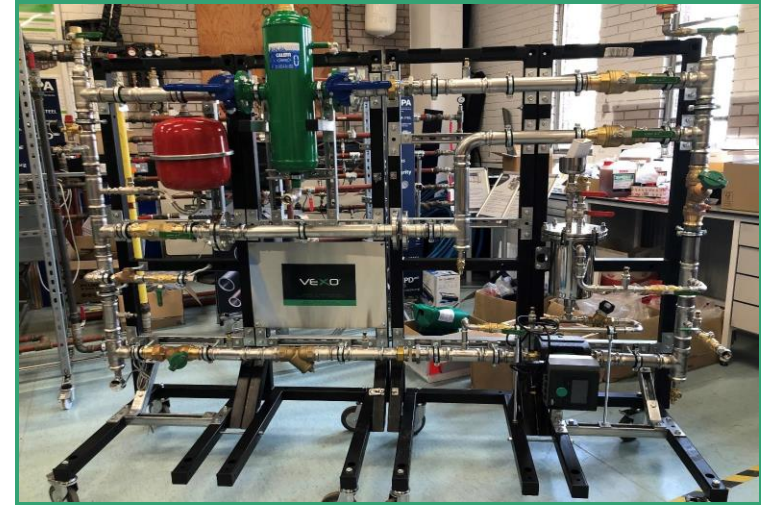

PhD Research – Interim Report Summary Extract

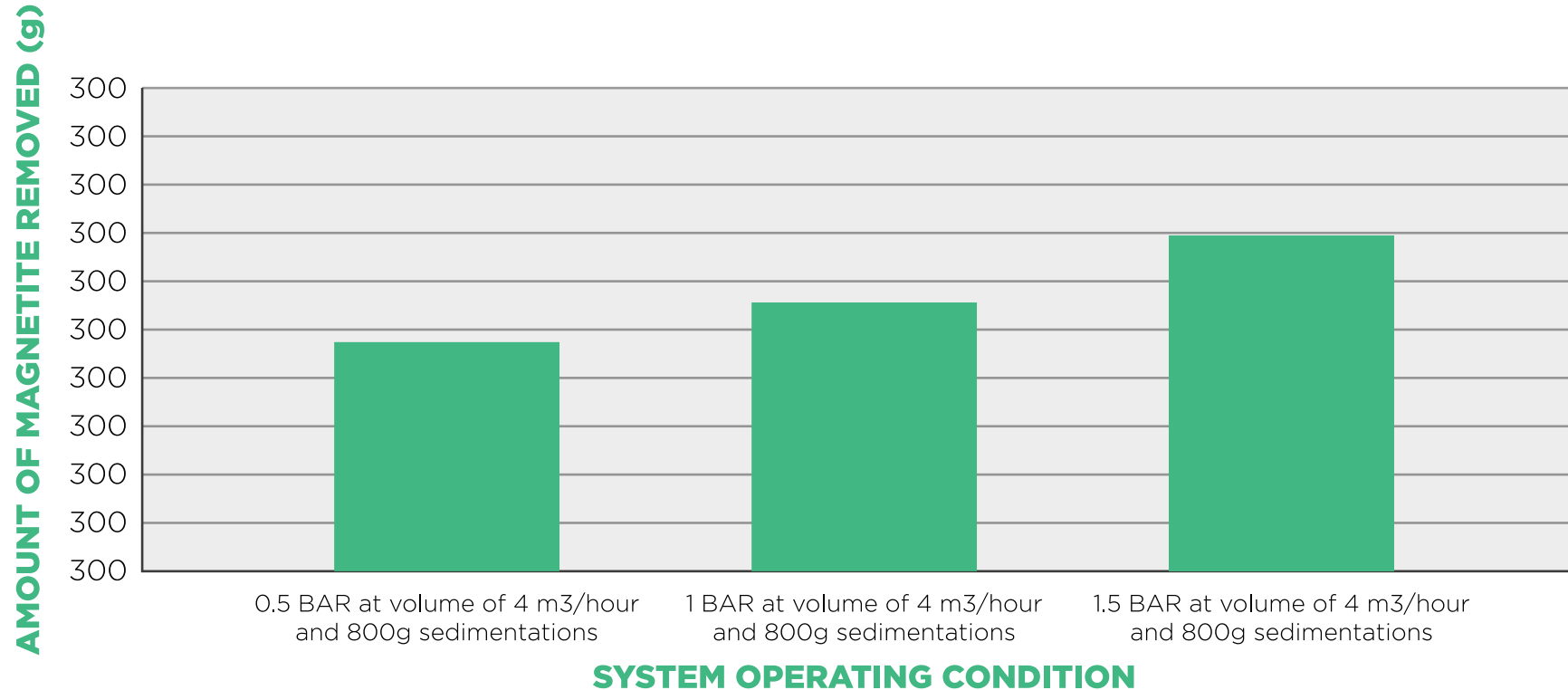

The results show that poor water quality not only leads to plant failure but significantly increase the pump energy consumption. In some cases, savings of up to 80% were recorded for cleaning the water.

3. Water Quality Specification Resources



BSRIA BG29/2021 provides invaluable guidance to design engineers and water treatment specialist of how to apply best practice within their design and scope of work.



BSRIA BG50/2021

- Advice on principles of treatment
- Nonprescriptive
- Needs expert application
- FM relevance (post practical completion)

Closed System Control Association



The [Closed System Control Association](#) provides a list of audited & accredited companies who carry out Pre-Commissioning Cleaning, and on-going water treatment maintenance for closed loop systems to UK best practice standards. By specifying [BSRIA BG29/2021](#) as the standard for cleaning and [BSRIA BG50-2021](#) for ongoing maintenance - whilst also specifying accredited CSCA contractors to carry out the work, will ensure best practice and mitigate the loss of system efficiency and operational lifecycle of system components from the effects of poor water quality.

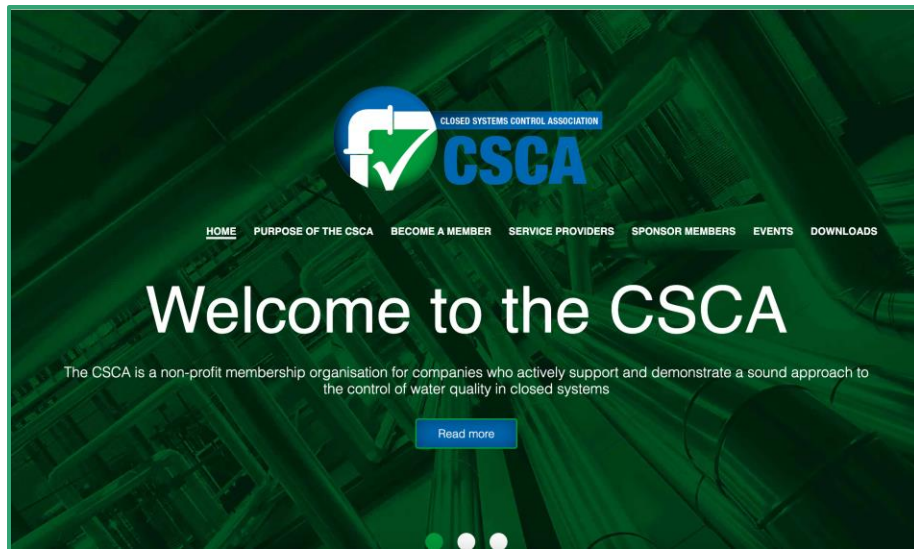

Sampling 'Cradle to Grave'



- BS8552
- Tests
- Locations
- Frequencies
- No interpretation
- All stages of building life

The BSI guide helps with sample interpretation. A competent water treatment specialist is needed to interpret results.

German Standard VDI 2035

VEREIN DEUTSCHER INGENIEURE

Vermeidung von Schäden in Warmwasser-Heizungsanlagen
Heizwasserseitige Korrosion
Prevention of damage in water heating installations
Water-side corrosion

VDI 2035
Blatt 2 / Part 2

Das deutsche Verzeichnis dieser Richtlinie ist verbindlich.

The German version of this guideline shall be taken as authoritative. No guarantee can be given with regard to the English translation.

Inhalt	Seite	Contents	Page
Vorbereitung	2	Preliminary note	2
Einführung	3	Introduction	3
1 Anwendungsbereich	4	1 Scope	4
2 Normative Verweise	5	2 Normative references	5
3 Begriffe	5	3 Terms and definitions	5
4 Grundsätze	5	4 Basic principles	5
5 Relative Korrosionsarten und Korrosionsschäden	6	5 Relevant forms of corrosion and corrosion damage	6
5.1 Korrosionsarten	6	5.1 Forms of corrosion	6
5.2 Korrosionsschäden	6	5.2 Corrosion damage	6
6 Korrosionsursachen und Einflussfaktoren	7	6 Causes of corrosion and influencing factors	7
6.1 Allgemeines	9	6.1 General comments	9
6.2 Sauerstoff	9	6.2 Oxygen	9
6.3 pH-Wert	9	6.3 pH value	9
6.4 Elektrische Leitfähigkeit	10	6.4 Electrical conductivity	10
6.5 Summe Erdalkalien	10	6.5 Sum of alkaline earths	10
7 Korrosionsschäden	10	7 Corrosion damage	10
7.1 Allgemeines	10	7.1 General comments	10
7.2 Unedige und niedrig legierte Eisenwerkstoffe	11	7.2 Unalloyed and low-alloyed ferrous materials	11
7.3 Kupfer und Kupferlegierung	12	7.3 Copper and copper alloys	12
7.4 Aluminium und Aluminiumlegierung	13	7.4 Aluminium and aluminium alloys	13
7.5 Nichtrostender Stahl	13	7.5 Stainless steel	13
7.6 Kunststoff und sonstige Bauteile	14	7.6 Plastics and other components	14
7.7 Chemische und Beschichtungen	15	7.7 Coatings	15
7.8 Mischmetalle	15	7.8 Mixed installations	15
7.9 Sonstige Einflüsse	16	7.9 Other factors	16

VDI-Gesellschaft Bauen und Gebäudetechnik
Fachbereich Technische Gebäudetechnik

The emphasis of this part of the guide is that in a professionally planned and constructed system, oxygen corrosion is prevented without the use of chemicals during proper operation. The oxygen content can be reduced and kept low by correct start-up of the plant, deaeration, correct pressure maintenance and the design of the system in preventing air (oxygen) ingress.

More common now for DHN systems where air ingress is minimal, and the cost of the equipment is not prohibitive owing to the DHN installation and operational costs.

THANK YOU



Technical Support

Tel: +44 (0) 1767 500 150
Email: technical@vexoint.com



Sales Support

Tel: +44 (0) 1767 500 150
Email: sales@vexoint.com



BOOK A DEMO

vexoint.com/book-a-demo

