

CIBSE Application Manual AM11 'Building Performance Modelling'

Chapter 6: Ventilation Modelling

Contents

- Background
- Ventilation modelling tool categories
- Simple tools and estimation techniques
- Analytical methods
- Zonal network methods
- Computational Fluid Dynamics (CFD)
- Semi-external spaces
- Summary and conclusions

Prof Darren Woolf, Hoare Lea & Loughborough

University

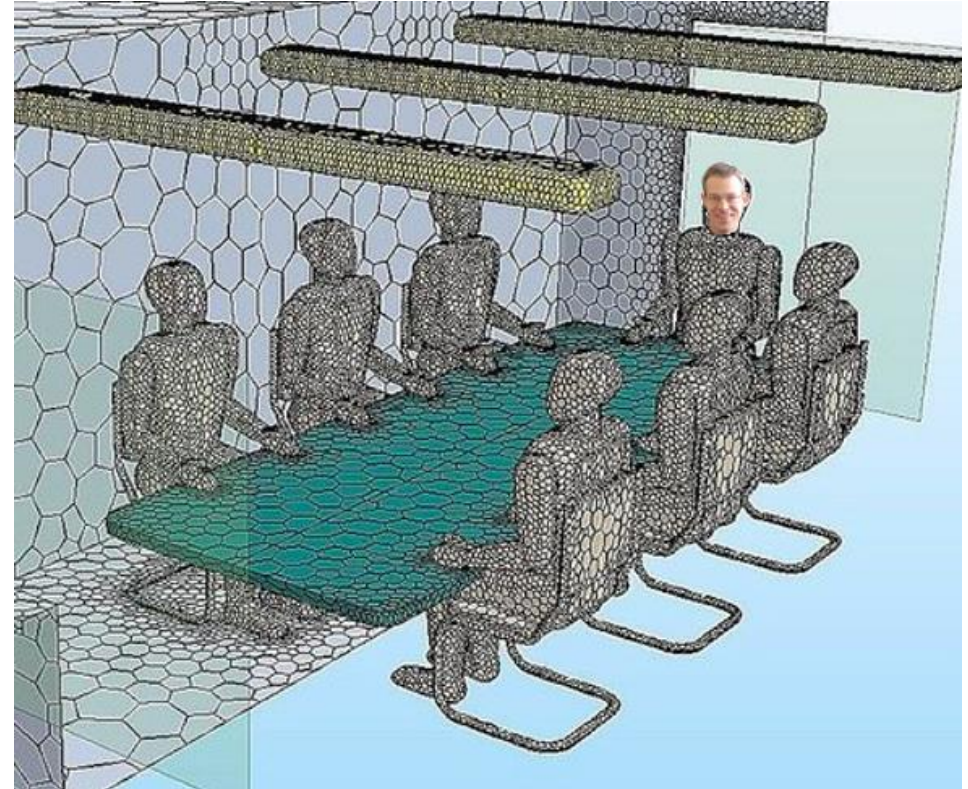

Chapter 6 authors (Prof Malcolm Cook principal

CIBSE Application Manual AM11 'Building Performance Modelling'

Chapter 6: Ventilation Modelling

Background [Section 6.1]

Key issues:

- Natural ventilation
- Mechanical ventilation
- Air infiltration
- Indoor air quality
- Thermal comfort
- Energy usage

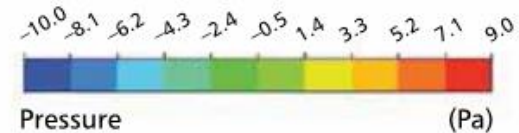
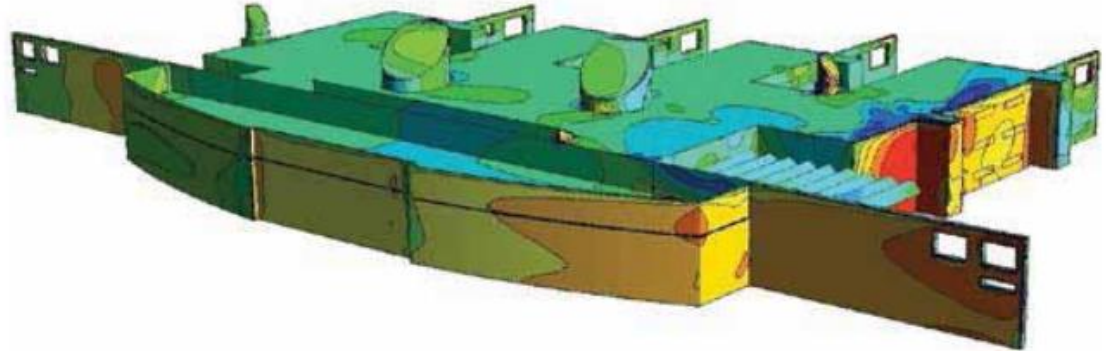

Surface air pressures supporting the design of a natural ventilation system (Fig. 9.21)

CIBSE Application Manual AM11 'Building Performance Modelling'

Chapter 6: Ventilation Modelling

Ventilation modelling tools categories [Section

6.21

Complexity &
detail

Category	Typical highlights and outputs
Simple tools and estimation techniques	Rules of thumb and charts that are very quick and easy to use Air flow rate and required opening area
Analytical methods	Simple linear equations by hand or spread sheet Stack pressures or stratification heights
Zonal network methods	Simultaneous, non-linear, equations using computer Large volumes / zones of air connected within flow resistance network Air temperatures, pollutant concentrations, air flow rates in each zone over year Coupling with dynamic thermal models
Computational fluid dynamics (CFD)	Complex, non-linear, differential equations using computer Small volumes form computational mesh Air temperature, air velocity and pollutant concentration distributions at one point in time

[Table 6.1]

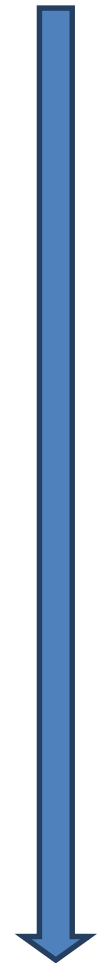

CIBSE Application Manual AM11 'Building Performance Modelling'

Chapter 6: Ventilation Modelling

Simple tools and estimation techniques [Section 6.2.2]

Example application:

- Concept design for natural ventilation (see right)
- For a 3K in/out air temperature difference, a neutral pressure level calculated to be 9m from opening leads to an 'air flow rate to effective area' ratio of $0.8 \text{ m}^3/\text{s}\cdot\text{m}^2$
- A doubling of effective area will halve flow rate
- Very simplistic in nature but you can apply a similar approach for more complex air flow

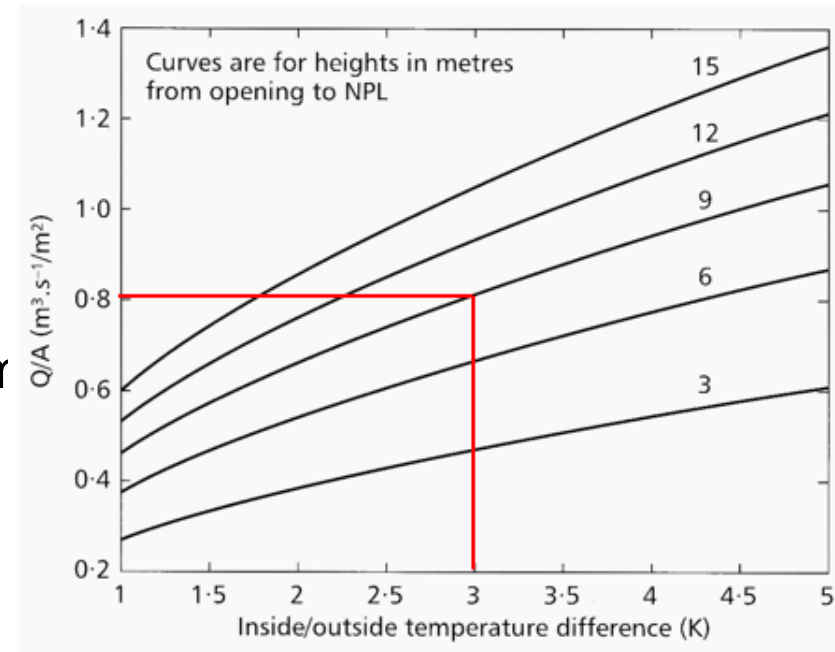

[Fig. 6.1]

CIBSE Application Manual AM11 'Building Performance Modelling'

Chapter 6: Ventilation Modelling

Analytical models [Section 6.2.3]

Example application:

- Three-storey building connected to an atrium
- Flow rate through an opening as a function of pressure difference across it
- Tables for discharge coefficient (opening configuration) and exponent (laminar to turbulent flow)
- Model gives required effective opening area for a given ventilation rate
- As working from equations, more flexible than

$$\dot{q}_m = C \Delta P^n$$

\dot{q}_m = flow rate through opening (m³/s)
 C = flow coefficient (m³/s/Paⁿ)
 n = flow exponent (-)
 Δp = driving pressure across opening (Pa)

[Eqn. 6.1]

Wind and stack driven flow					
Choices					
Flow mode		Wind-driven flow			
Partition		No partition			
Geometry		General data		Wind-driven mode	
Floor-to-ceiling height	3 [m]	Internal temperature	27 [°C]	Wind speed	6 [m/s]
Slab thickness	0.5 [m]	External temperature	24 [°C]	Pressure coefficient inlet	0.25 [-]
Stack height from roof	2 [m]			Pressure coefficient outlet	-0.7 [-]
Neutral pressure level	10.35 [m]				
Opening 1		Opening 2		Opening 3	
Height opening centre	1.2 [m]	Height opening centre	1.2 [m]	Height opening centre	1.2 [m]
Flow rate	0.27 [m ³ /s]	Flow rate	0.27 [m ³ /s]	Flow rate	0.27 [m ³ /s]
Discharge coefficient	0.61 [-]	Discharge coefficient	0.61 [-]	Discharge coefficient	0.61 [-]
Distance from NPL	3.15 [m]	Distance from NPL	5.65 [m]	Distance from NPL	2.15 [m]
Wind pressure	10.260 [Pa]	Wind pressure	10.260 [Pa]	Wind pressure	10.260 [Pa]
Area inlet	0.11 [m ²]	Area inlet	0.11 [m ²]	Area inlet	0.11 [m ²]
Outlet					
Discharge coefficient		0.61 [-]			
Flow rate		0.81 [m ³ /s]			
Distance from NPL		2.15 [m]			
Wind pressure		10.260 [Pa]			
Area inlet		0.32 [m ²]			

CIBSE Application Manual AM11 'Building Performance Modelling'

Chapter 6: Ventilation Modelling

Zonal network methods [Section 6.3]

Key issues:

- Each zone 'well mixed', single data point. Is that adequate for current design stage and study objectives?
- Network can be made up of different space and zone combinations. Need to be designed. How might choices impact results and interpreted message?
- Filtering of known and unknown (assumed) design information.

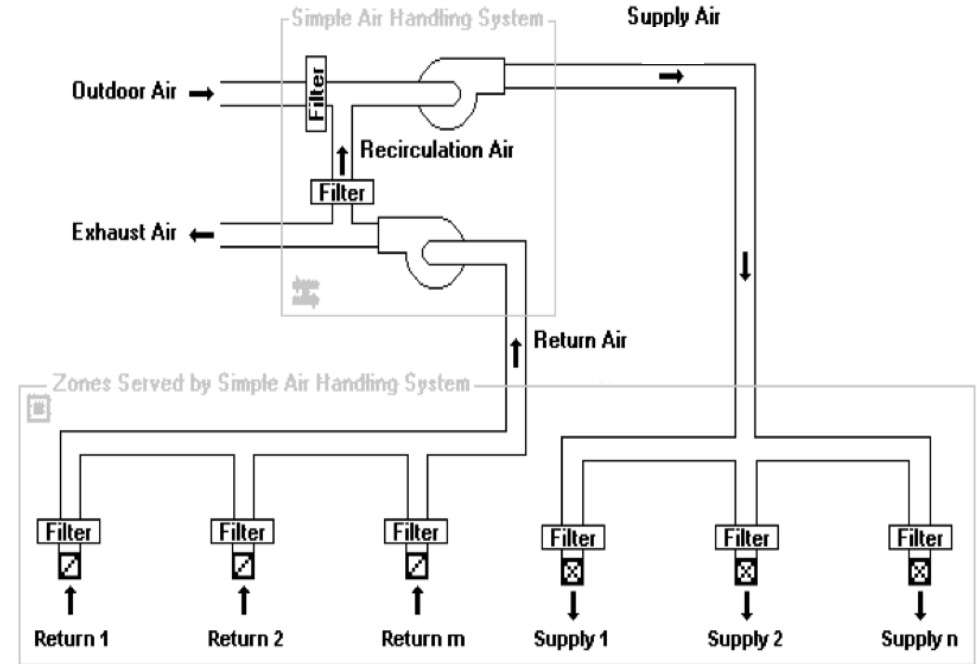

Simple air handling system in a zonal network model [Fig

- Different procedures / strategies.
- Choice of climate data.

Translation into suitable boundary conditions.

CIBSE Application Manual AM11 'Building Performance Mode

Chapter 6: Ventilation Modelling

Zonal network methods [Section 6.3]

Applications:

- Includes flow equations, e.g. flow through opening and/or cracks for infiltration / exfiltration, so method can be applied to the natural ventilation design for a full building model or a lift shaft connected to a reception lobby, for example.
- Mechanical ventilation systems can be represented as an injection of air at a specified flow rate and temperature into a zone. Mechanical systems models (e.g. including fan performance curves) can be developed with more advanced controls if required (e.g. flow rates change according to contaminant levels).

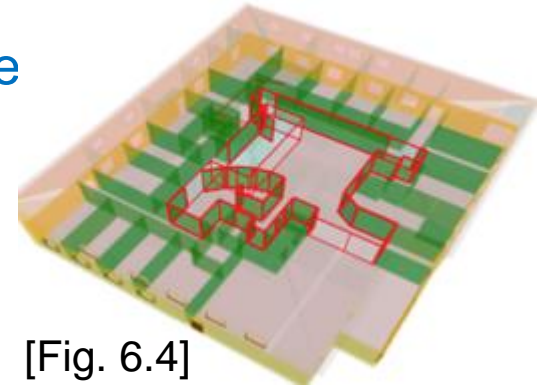

[Fig. 6.4]

- Smoke dilution strategies, ventilated facades and car park ventilation systems.

CIBSE Application Manual AM11 'Building Performance Modelling'

Chapter 6: Ventilation Modelling

Zonal network methods [Section 6.3]

Limitations and other considerations:

- Flow directions may need to be assumed if not used with other software, e.g. to derive wind pressure coefficients
- Good for sensitivity studies (quick) but may need to move towards more detailed studies at later design stages, e.g. becoming verification support for CFD.
- Lack of spatial detail (single point per zone)
- Insensitivity to zone shape (long narrow same as cuboid)
- Insensitivity to flow momentum (no wind-induced 'jetting')
- Needs to be coupled to a dynamic thermal model for more detailed

assessments, e.g. thermal comfort including solar / thermal radiation with surface temperatures



Computational fluid dynamics (CFD) [Section 6.4]

Key issues:

- When to use CFD, e.g. if additional spatial resolution needed to drive mechanical design
- Complex technique needing background understanding plus good skills to drive well and deliver 'measured' message
- Which turbulence and other mathematical models to apply
- Guidance on specifying boundary conditions

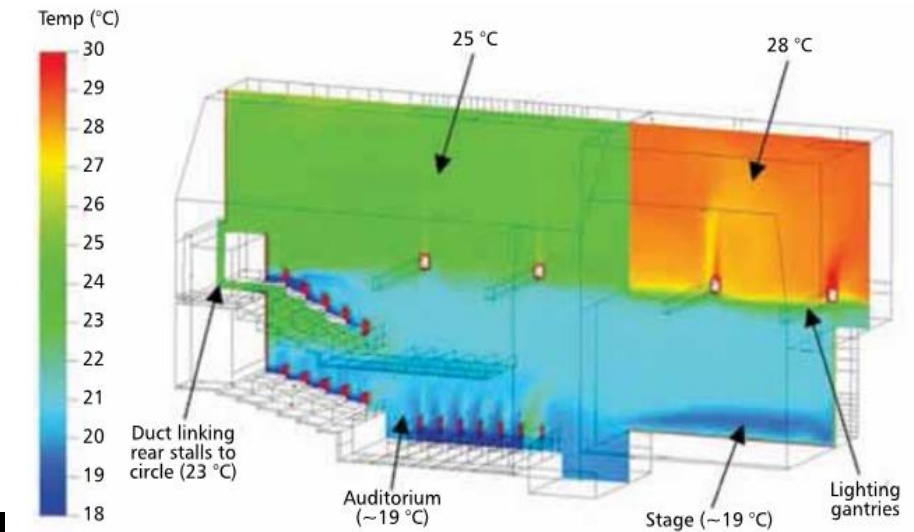

Air temperature stratification in auditorium [Fig. 6.5]

- Construction of model using poor quality geometry – quick mesh \neq good mesh

Computational fluid dynamics (CFD) [Section 6.4]

Applications:

- Most commonly steady-state CFD at 'design day/hour' taken from a dynamic thermal model that resolves the solar / thermal radiant distribution (CFD for convection only)
- Sometimes flow and heat physics is inherently transient / unstable requiring a time dependent solution, e.g. cold surfaces overhead

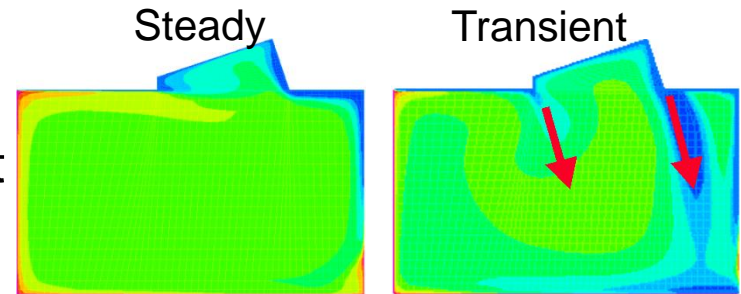

[Fig. 6.8]

- Moisture transport – Separate software is often used to determine moisture transport through the building fabric but condensation risk using CFD with moisture sources from people / food / water features is commonly employed

Computational fluid dynamics (CFD) [Section 6.4]

Applications:

- Radiation modelling – CFD has solar and thermal radiation capabilities but requires careful consideration in application. For example, if used with a dynamic thermal model, you need to ensure no heat loads are double-counted or left out, e.g. by using external effective or sol-air temperatures with a building fabric resistance model.
- Contaminant transport via gas concentrations (with/without density) may be used to understand CO₂ levels in a classroom or infection risk in a hospital. Technique can be extended via particle tracking to rain drops

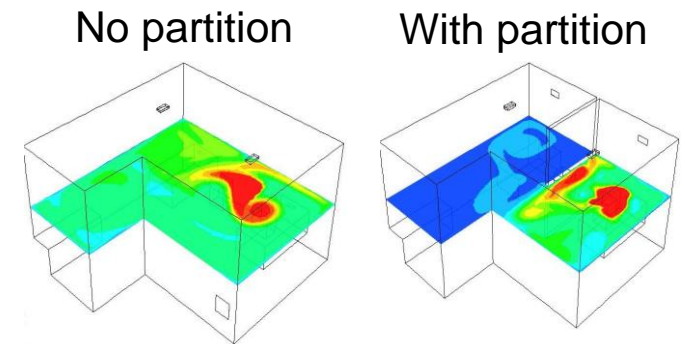

Infection risk

[Fig. 6.9]

CIBSE Application Manual AM11 'Building Performance Modelling'

Chapter 6: Ventilation Modelling

Computational fluid dynamics (CFD) [Section 6.4]

Applications: Turbulence models

GENERIC TYPES & NAMES	NOTES ON APPLICATION
<u>RANS</u> (Reynolds-averaged Navier Stokes) variants – small and large scale model for turbulence	
k-epsilon, RNG (Renormalisation group theory), k-omega, SST (Shear stress transport), RSM (Reynolds stress model)	<ul style="list-style-type: none">• Availability and robustness• Choice may be dependent on strengths of one model over another, e.g. buoyant plumes, flow separation, adverse pressure flows
<u>LES</u> (Large Eddy Simulation) variants – resolves large scale turbulent eddies, model for small scale	
LES (Large Eddy Simulation), DES (Detached Eddy Simulation – LES/RANS blend)	<ul style="list-style-type: none">• Very computationally intensive / time dependent• Additional strengths / ability to capture flow physics, e.g. fluctuating flows for wind and turbulent plumes
<u>DNS</u> (Direct Numerical Simulation) – resolves small and large scale turbulent eddies	
DNS (Direct Numerical Simulation)	<ul style="list-style-type: none">• Extremely computationally intensive• <u>Currently</u> not an industrial approach – in 2030?

[Table 6.3]

Computational fluid dynamics (CFD) [Section 6.4]

Limitations and other considerations:

- Solid boundaries (e.g. walls and windows) often have temperatures and/or heat fluxes fixed to the surface – a warm jet on cold glass may require the temperature to vary over the surface requiring a different approach. A 'wall function' model is often used to capture heat / flow phenomena in boundary layer next to surface.
- A conjugate heat transfer approach may include heat transfer in solid elements but does not practically capture the thermal dynamics of the building envelope.
- Flow boundaries (e.g. supply air grilles and openings) are used to exchange air, moisture and contaminants in the model. Small-scale features (e.g.

Computational fluid dynamics (CFD) [Section 6.4]

Limitations and other considerations:

- Many approaches to constructing computational mesh. What's available?

What's best for application? What's best strategic approach, e.g. using architectural CAD model as construction lines only or tidy up or 'wrap and de-feature'? What's the most effective / efficient cell shapes, e.g.

- ~~Strategic approach~~ **Strategic approach** needed to control the solution including location of monitor points and use of 'under-relaxation' where software vendor guidelines may be needed to achieve convergence (or acceptance of instabilities)

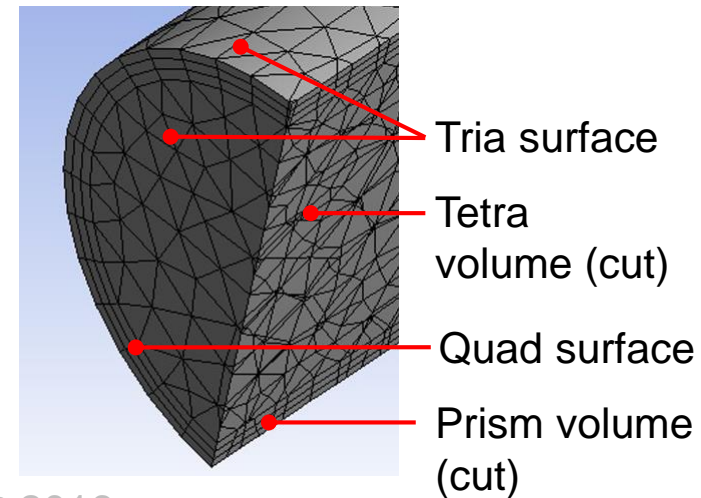

Computational fluid dynamics (CFD) [Section 6.4]

Limitations and other considerations:

- Model outputs need to be designed in order to support key messages and deliver study objectives. Balance required on quantity of plots and how they're displayed, e.g. an isometric view with velocity (or temperature) streamlines may describe many characteristics. Sometimes it's best to use an appendix for results bringing forward key images into main text. 3D and transient

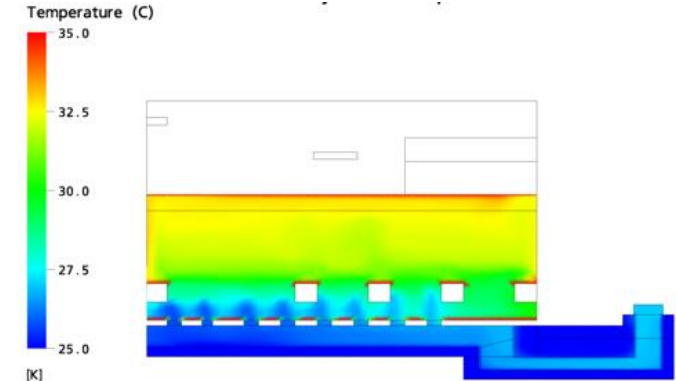

Air temperature contours on a plane [Fig. 6.20]

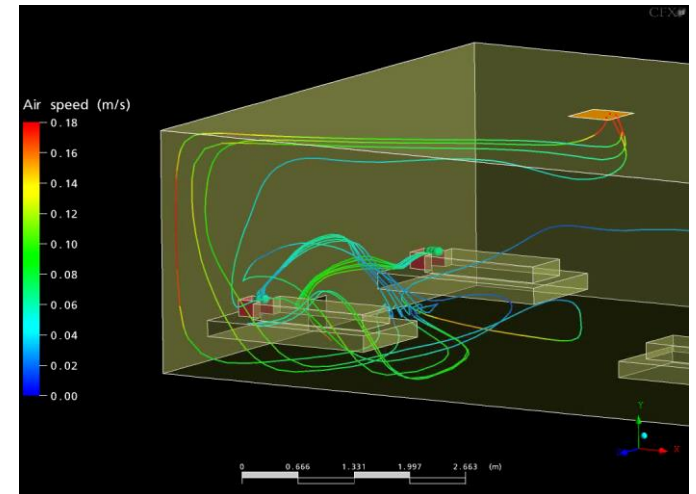

Velocity streamlines [Fig. 6.23]

Computational fluid dynamics (CFD) [Section 6.4]

Limitations and other considerations:

- Treatment of surfaces are important, e.g. representation of friction or roughness. This may use a model where 'first cell height' is important to consider or be represented explicitly using blocks resulting in an increase in the total number of cells.
- Air volumes, e.g. an occupied zone, may be separated out to treat differently. This may include injection of the convective component of internal heat gains (e.g. people, small power & lights) or to modify porosity (e.g. furniture, balustrades).
- Beware of claims of 'accurate solutions' but CFD more detailed than other methods. Need to apply 'best practice' and then carry out many checks.

CIBSE Application Manual AM11 'Building Performance Modelling'

Chapter 6: Ventilation Modelling

Computational fluid dynamics (CFD) [Section 6.4]

Limitations and other considerations:

- Differentiation needed between user error (most common), numerical errors (needs checks and balances), physical model limitations (e.g. turbulence, radiation)
- Inherent differences when interfacing CFD with other software, e.g. dynamic thermal model or light ray tracing. Knowledge required on strengths / weaknesses and limitations of all approaches.

Semi-external spaces [Section 6.5]

Key issues:

- Treatment of ground plane for surface roughness, e.g. buildings, trees
- Flow boundary conditions, e.g. inlet
- Turbulence associated with environmental flows, e.g. LES CFD
- Capturing different scales, e.g. kilometre-scale upstream to metre-scale at building
- Interfacing with internal areas
- Long term assessments, e.g. hours over

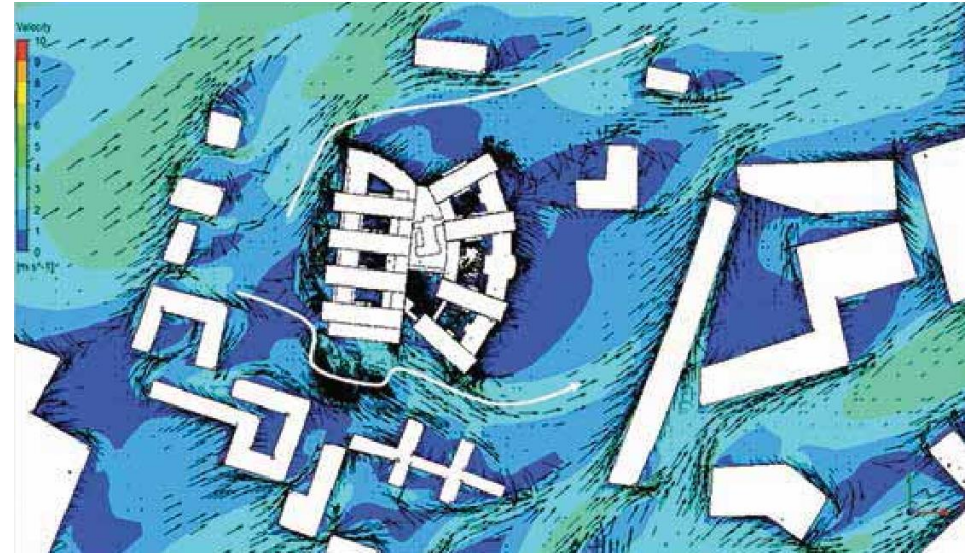

Wind patterns around buildings [Fig. 6.28]

Semi-external spaces [Section 6.5]

Applications:

- Influence of external space on internal, e.g. design of entrances / air infiltration
- Assessment of wind comfort and safety (Lawson Criteria)
- Complementary to wind tunnels for isothermal flows
- Use of different comfort indices and combining with solar-thermal environment, e.g. Physiological Equivalent Temperature – PET

Summary and conclusions

- Some of the more simple ventilation modelling techniques should be used at early stage but are highly simplistic in nature, so limited. They can provide direction and 'partial' verification for more complex techniques.
- Zonal network methods, often coupled with dynamic thermal models, are quick to solve and powerful for sensitivity studies. Limitations need to be recognised.
- CFD is complex in nature but can provide necessary detail. Quite versatile but still limited depending on application. Needs good skills to drive and more often being integrated with other software techniques.
- External / semi-external environmental models used independently or to determine impact on internal spaces. Many challenges from scale to capture