

October 2023

NABERS UK through the lens of a modeller and two members of the IDR CIBSE Building Simulation Group

CIBSE Building Simulation Awards

Launch of the awards

October 2023						
M	T	W	T	F	S	N
2	3	4	5	6	7	8
9	10	11	12	13	14	15
16	17	18	19	20	21	22
23	24	25	26	27	28	29
30	31	32				

Deadline

Winners will be announced at an event as part of the Build2Perform programme, **5th December.**



With you today

1

**Claire
Das Bhaumik**

Partner
Inkling LLP



2

**Darren
Coppins**

Director
Built Physics Limited



3

**Hugh
Gordon**

Associate
Hilson Moran



4

**Owen
Boswell**

Senior Associate
Hoare Lea



Agenda

1

Introduction to NABERS

A journey through time

Darren Coppins

2

Navigating NABERS UK

A modeller's perspective

Owen Boswell

3

Navigating NABERS UK Independent Design Review panel's perspective

Hugh Gordon &
Claire Das Bhaumik

4

Closing Remarks and Scheme Updates

Darren Coppins

5

Q&A

All

An introduction to NABERS

A journey through time

An introduction to NABERS

- National Australian Built Environment Rating System.
- Deployed 24 years ago in New South Wales.
- Main purpose is to rate buildings in use with ratings of zero to 6 stars.
- A rating is based on actual energy consumption.
- Applicable to Whole Building, Base Building and Tenancies.



An introduction to NABERS

- Now applied to over 84% of applicable buildings in Australia.
- Has resulted in a market transformation with significant energy reductions.
- Is considered one of the leading ratings systems in the world for influencing real change.

How do we know it works?



p.11 25 June 2018 Design for performance: modelling building energy performance for actual operation rather than regulatory purposes

Graph by Robert Cohen of Verco

An introduction to NABERS

- Introduced to the UK via an initiative lead by the Better Buildings Partnership.
- Research undertaken into its applicability to the UK market.
- Pilot programme undertaken in 2017.
- Development of the Design for Performance Framework.
- Funded & supported by a diverse range of stakeholders.

Funders



Project lead



Project team



Supporters



Additional thanks for support provided in the Pilot Programme



An introduction to NABERS

NABERS UK is currently available for:

- Offices only (currently).
- Base Building (Launched 2020).
- Tenancy (Launched 2023).
- Whole Building (Launched 2023).

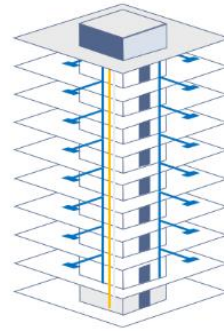

BASE BUILDING

Buildings can be rated based on their central services like heating and cooling systems, lifts and lobby lighting.

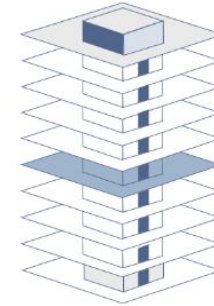

TENANCY

Enables energy used by the tenant to be rated, typically for lighting and power, plus special tenancy requirements or local a/c.

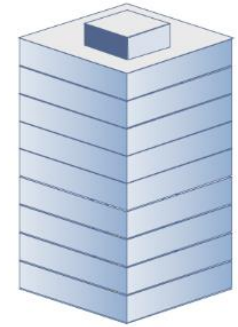

WHOLE BUILDING

Provides assessment of energy used by office tenancies and by Base Building services to lettable and common spaces.

An introduction to NABERS

Design for Performance

- Framework to enable new build and refurbishment projects to target and market a predicted NABERS UK rating.
- Requires an estimation of in use energy consumption which must be carried out in accordance with the NABERS UK Design for Performance Guide.

STEPS TO DESIGN FOR PERFORMANCE



1. SIGN UP YOUR PROJECT

Gain internal buy-in and sign a Design for Performance Agreement.

Commit to a minimum NABERS Energy rating of 4 Stars for office buildings.



2. PROMOTE TARGET RATING

Promote your project's target rating across marketing and media publications.

Communicate to investors and occupiers the aspirations of the project.



3. MODEL THE BUILDING AS IT WILL OPERATE

Communicate your target to the project team.

Design the building to operate at the target rating.

Advanced simulation is used to test the design against a range of expected operational conditions.



4. INDEPENDENT DESIGN REVIEW

Approach independent design reviewers to obtain 2-3 quotes.

The panelist you select will review the model to check whether the design will meet the target rating.



5. VERIFY YOUR RATING

Once the building has been occupied for 12 months, approach an accredited assessor to verify you've achieved your target rating.

An introduction to NABERS

Design for Performance

- Estimation model usually undertaken at RIBA Stage 4.
- Reflects a true estimate of the building performance as designed, with the NABERS assessment rules applied. **NOT** the best possible performance the building could achieve.
- Dynamic simulation with HVAC modelling is essential.
- Comprehensive simulation report is required, with sufficient detail to fully describe how the modelling was undertaken including all inputs and energy outputs.
- Simulation report, rating achievement plan and RIBA Stage 4 design information is then submitted for the Independent Design Review.

A modeller's perspective

"Tips and tricks" of successful modelling

A modeller's perspective

Walk before you run.

Ensure the principles for a low energy, high NABERS UK rating building is known from the outset.

- Resist the temptation to dive straight into simulation.
- Review the NABERS UK requirements. Retail units, metering etc...
- Architecture should help, not hinder you.
- Use BCO/LETI and other design guides to help drive the design.

A modeller's perspective

Challenge Everything.

No two people are the same, neither are buildings!

- Easiest route is to copy a strategy...but you may get to the wrong destination.
- Optimise the design to balance various project factors with NABERS UK e.g., plant sizing, enhanced air filtration for WELL etc...
- Continually question “is this the right solution”. Use the model to iterate, evaluate and advise.
- Unglamorous but...make sure you have a consistent naming convention and a simulation log file.

A modeller's perspective

Don't fear the IDR!

Embrace it! IDR reviewers want to make your project perform and operate better.

- It's a design team effort – Architect, client, MEP all need to contribute.
- Review the example simulation report. Make sure your report is near identical.
- Undertake two-stage review process if possible.
- Be honest about what the risks are and state how these intend to be mitigated e.g., manual opening windows, event spaces.
- State your assumptions. It's too hard to exact detail on every input, reasonable estimations with justification is suitable.
- Use the off-axis scenarios to evaluate the risk.

A modeller's perspective

Compelling real-life case study

NABERS UK and District Energy

Compelling real-life case study



A modeller's perspective

Case study



“Heat comes from the Bristol heat network, there’s a connection for Block A and Block C”.

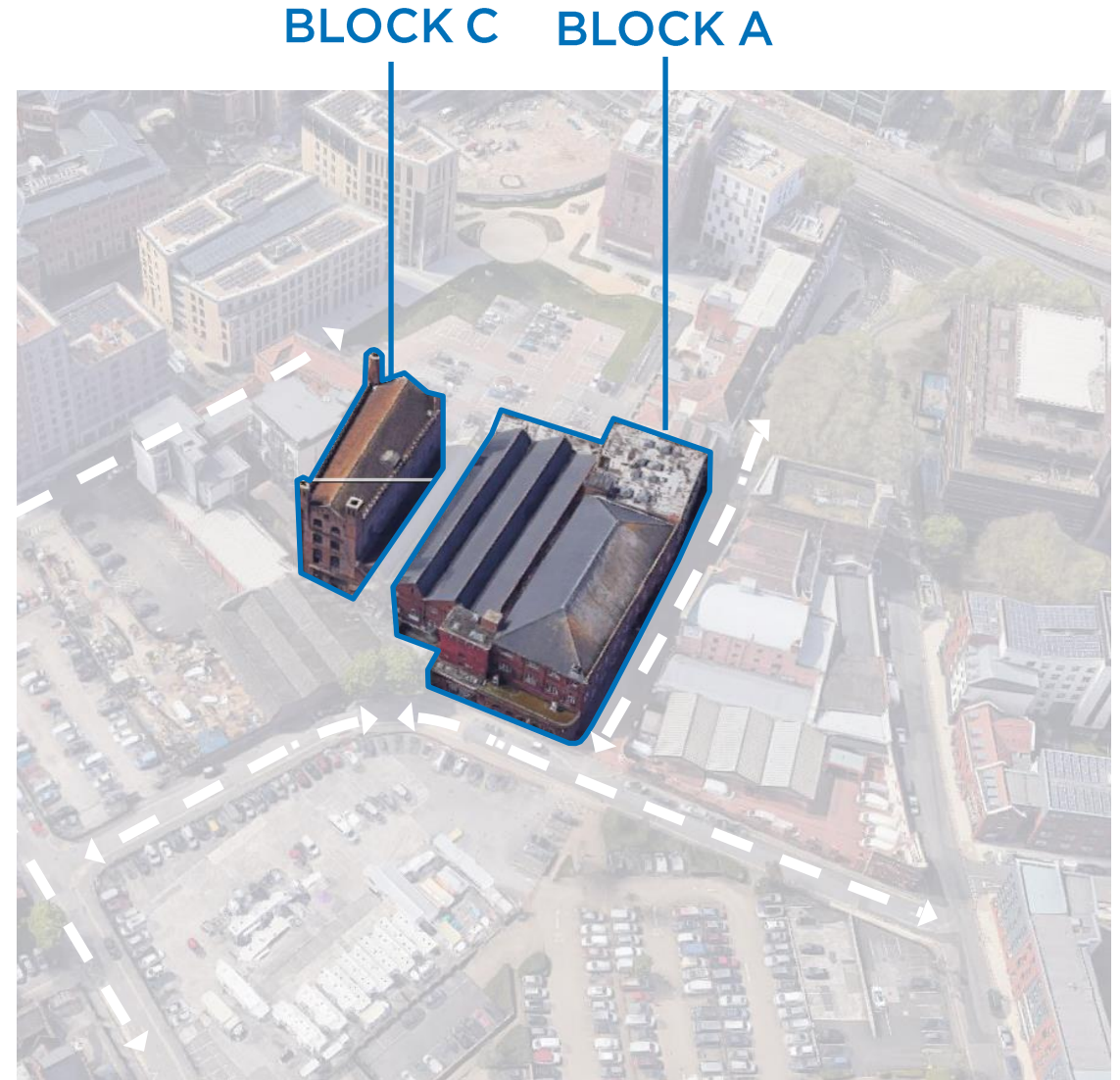

A modeller's perspective

Case study

! “Heat comes from the Bristol heat network, there’s a connection for Block A and Block C”.

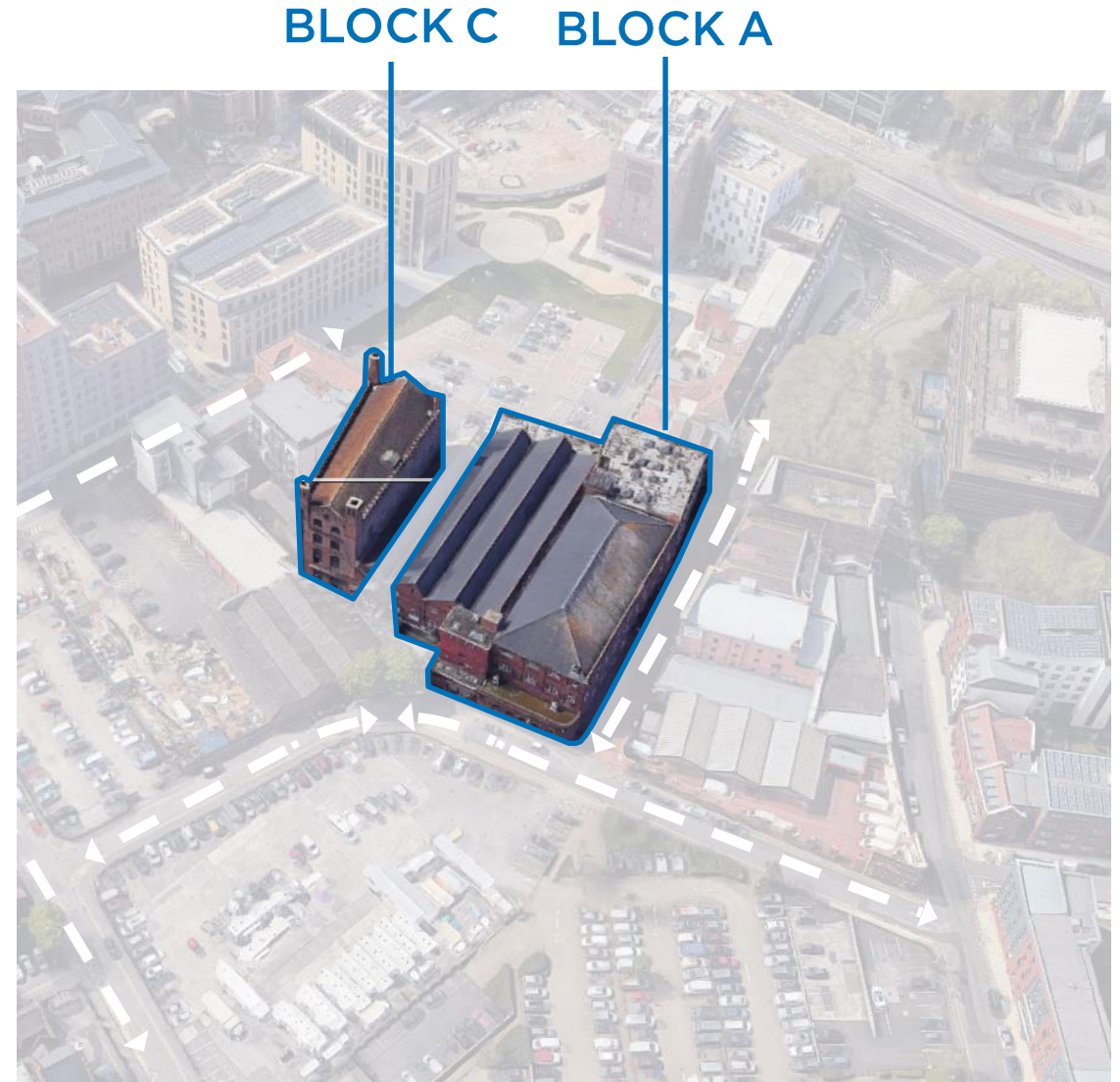
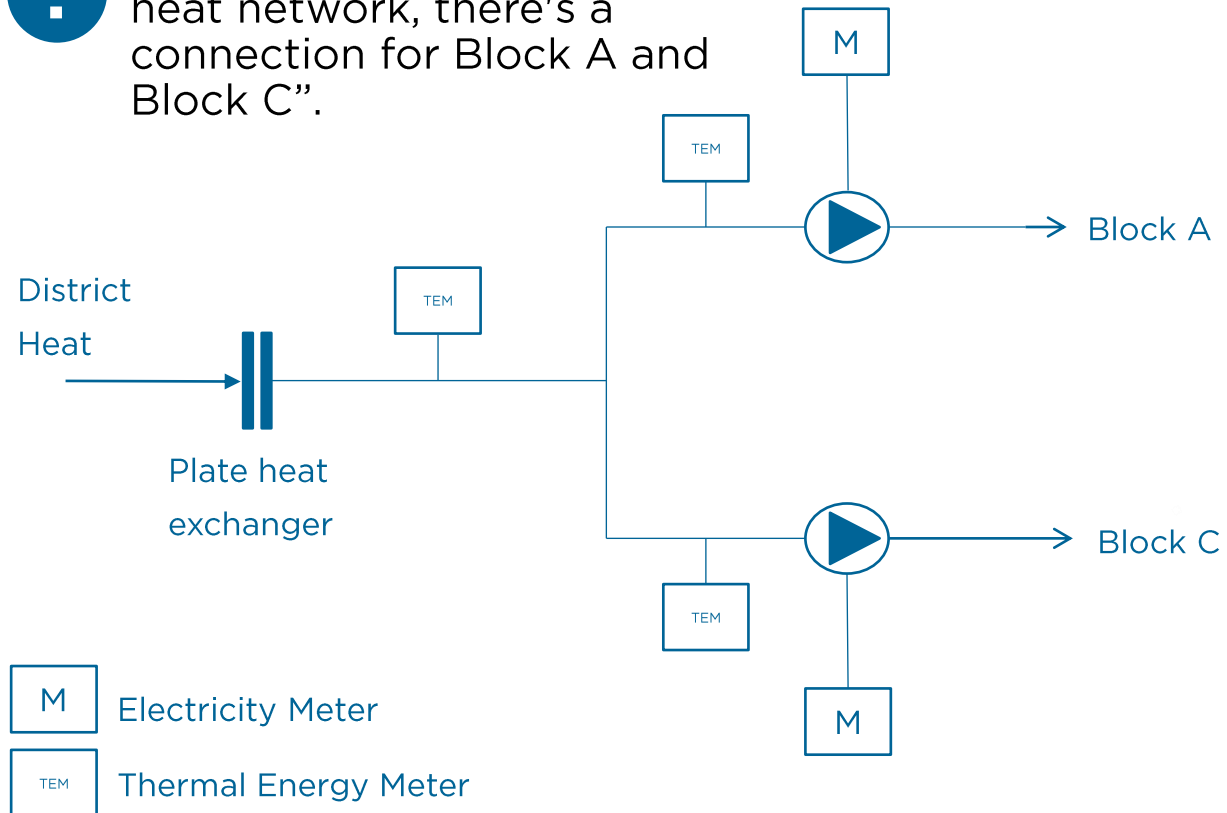

A modeller's perspective

Case study



“Due to space constraints Block C cooling is provided by the chillers on Block A. There’s a meter so we can exclude the energy”.

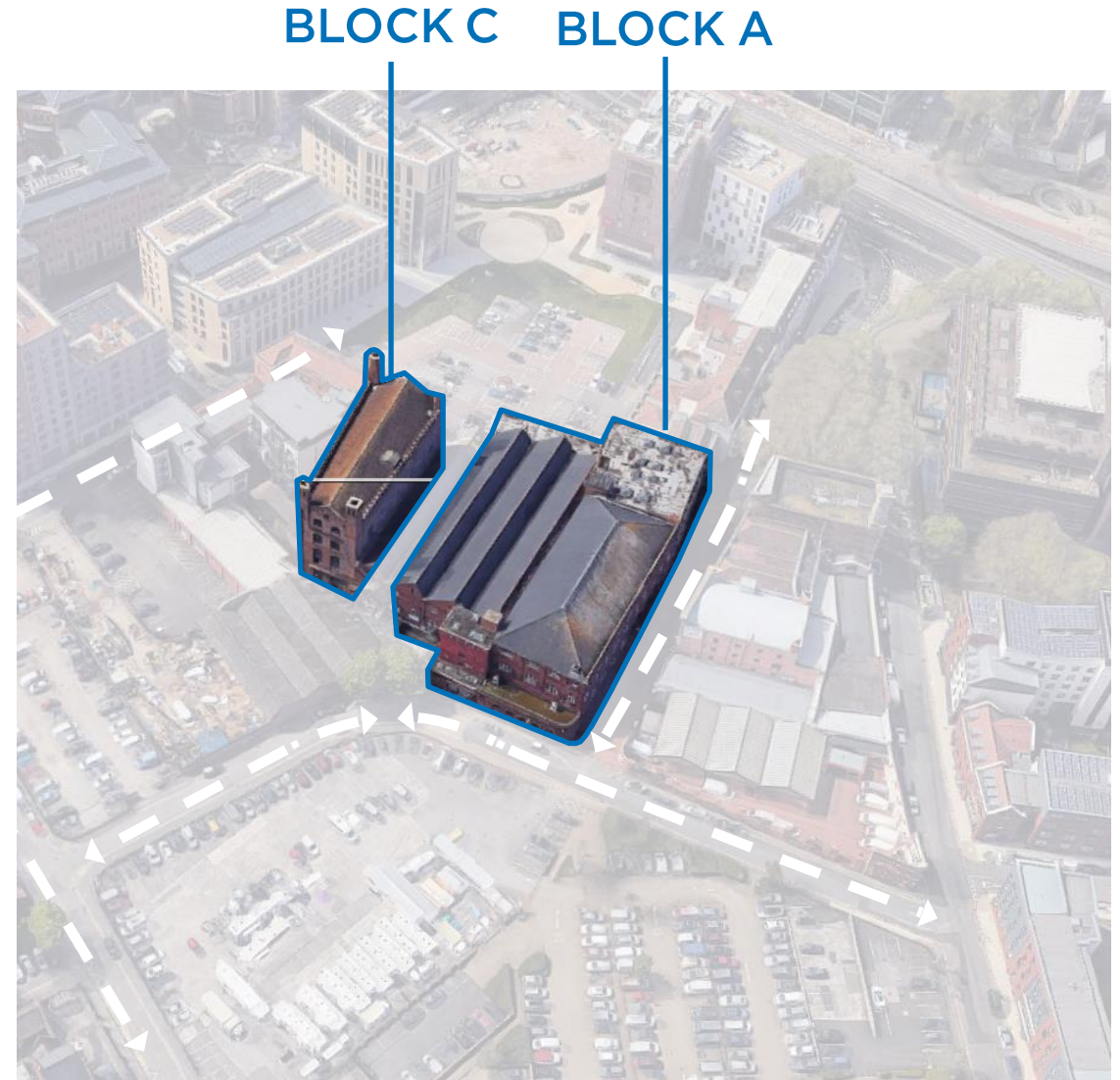

A modeller's perspective

Case study

- Chiller efficiency and electricity consumption is a factor of the load and external temperature.
- NABERS UK guidance states that the simulation should reflect the central plant loads.
- Thermal model expanded to include Block C.

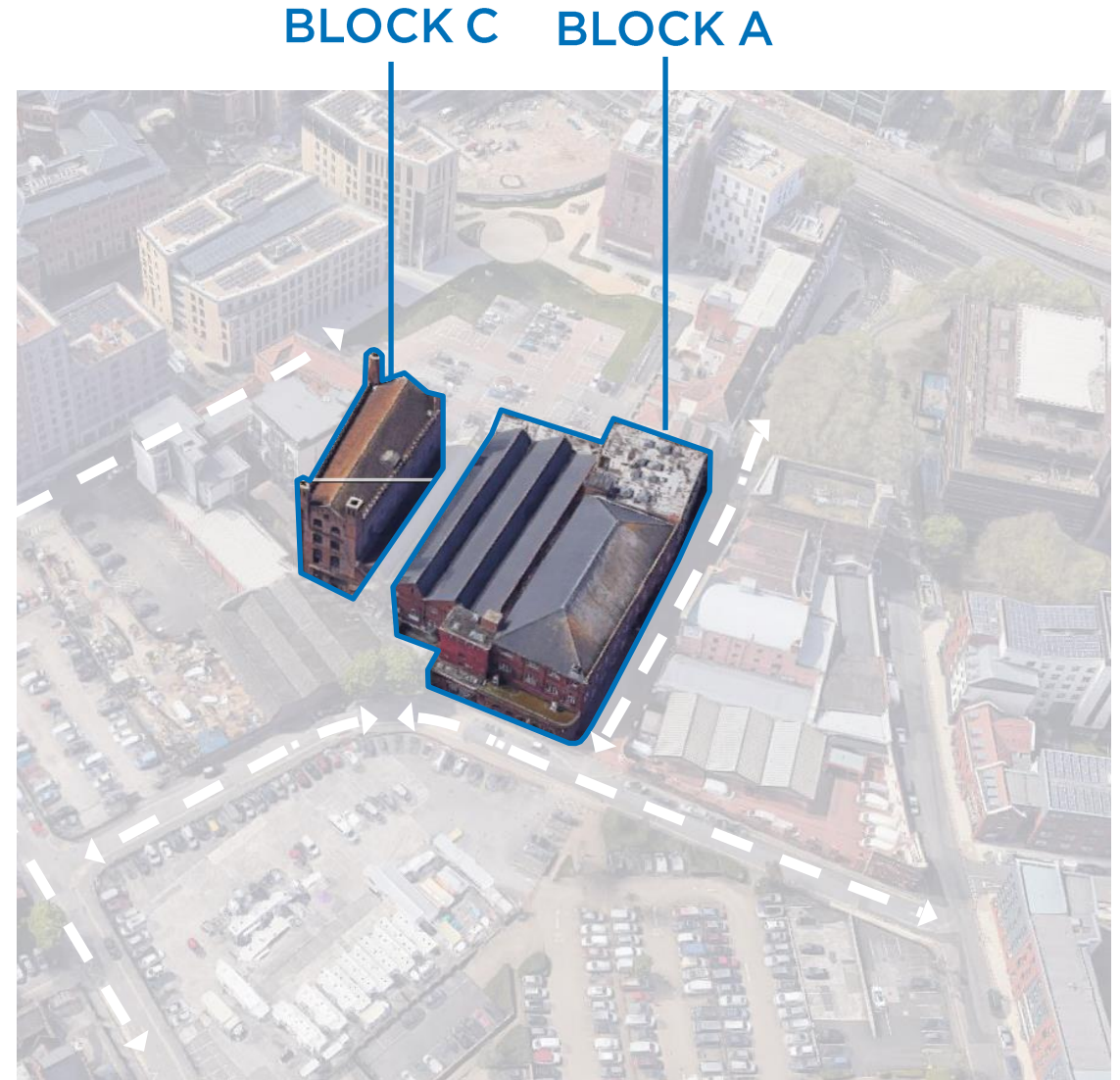

Independent Design Review panel's perspective

Purpose of simulation

Purpose of simulation

Representing likely performance



Model to accurately represent building/systems designed as possible.



Significant detail, time and care required in input into an advanced, dynamic model.

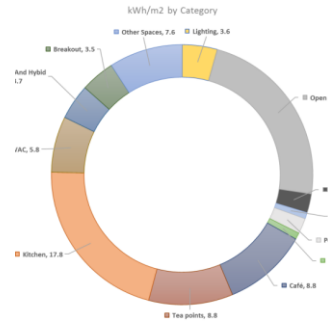

Corresponding levels of output looking at interdependency of numerous factors.



Significant value beyond benchmarking and this core requirement to reflect likely operation.



In earlier stages, understand, inform and influence future project decisions.

Purpose of simulation

Overlooked value and opportunity



Model should accurately represent building including plant sizing and control strategy.

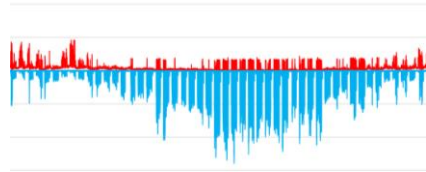

Providing earlier stage indication of demands which need to be most commonly met (and implications of plant turndown).



Utilisation to provide insight into alternatives and minimising specific risks.

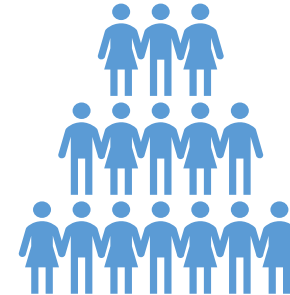

This value is often overlooked by modelers, and design teams due to: time constraints/ late implementation of advanced modelling.

Purpose of simulation

Sizing and control of plant

By leveraging the modelling/more detailed early-stage analysis and designing more closely to what is required it is possible to:

- Enhance system efficiency, and control, by ensuring oversized plant does not need to operate at significant turndown.
- Maximise design potential.
- Reduce capital cost and potentially embodied carbon associated with traditional oversizing.
- Care must still be taken to allow for redundancy and future flexibility necessary.



Accurate capacity, performance curves and minimum turndown of plant must be accounted for if the value of modelling is to be realised.

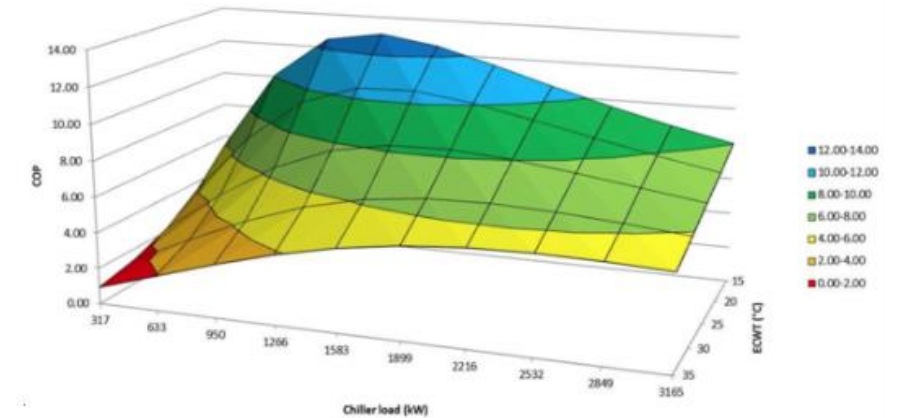
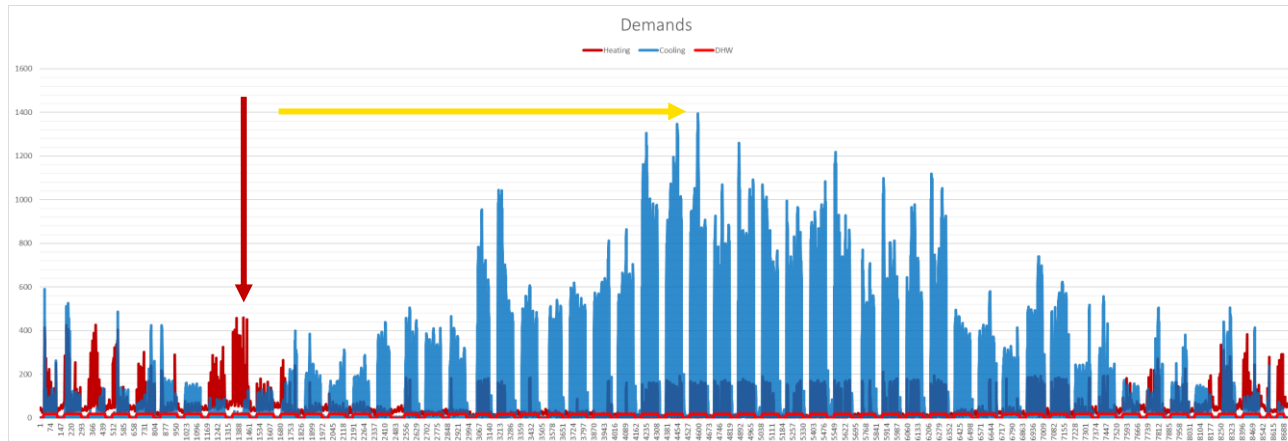

Purpose of simulation

Selection and control of central systems

- Use **annual demands projected by modelling**:
Insight into more efficient options/control strategies for the context.
- Could:
Thermal storage, further ability to recover heat, or the ideal balance of 4 vs 2 pipe Air source Heat pump units be better utilised?
- Superficial example:

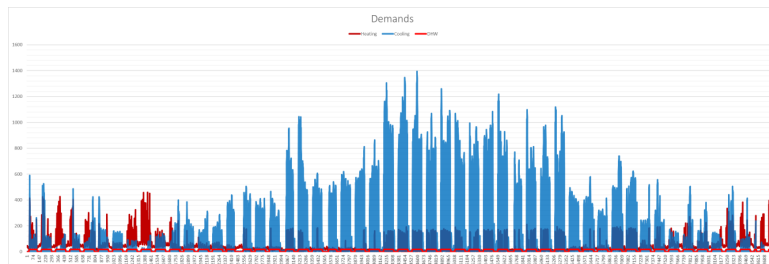

Projected annual demand for building with 4 pipe ASHPs

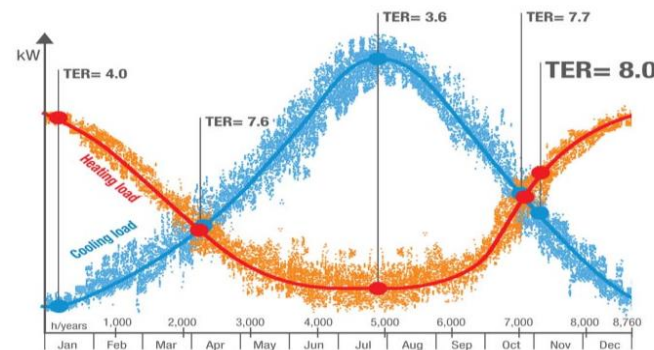

4 pipe ASHP efficiency

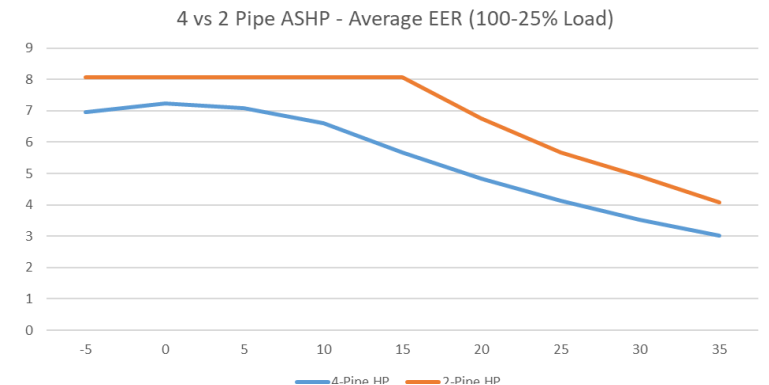

Comparative cooling efficiency

Purpose of simulation

Complex control and interdependency

Noting detail of the HVAC design and control are key to success. This area is often not modelled as effectively as it could be.

For complex control and interdependency analysis should be leveraged to:

- Find/explore an ideal strategy dependent on detail and context. Noting, and accounting for Inter-operation and dependency of systems, e.g.:
 - Will systems perimeter fancoils shut off when windows are open, what is the potential for conflict?
 - How will fresh air supply be impacted?
 - Could this fresh air supply help better meet cooling demands?
- Analysis/Quantification of risks when this is not used optimally, or outside the parameters envisaged.
- What is the insight as how to address risks in operation?



Within the central model to be reviewed:

Care must be taken to ensure the modelled control strategy matches likely operation.



Independent Design Review panel's perspective

How can simulation be improved?

How can simulation be improved?

Thermal comfort/ unmet hours

- Model should accurately represent building including plant sizing.
- Unmet hours highlight undersized/ oversized systems and poor control.
- In reality more energy would be used to create comfortable conditions.
- Unmet hours are a risk to the design.

Zone	Air temperature (°C) - % hours in range		
	< (Heating set point-1)	Controlled band	> (Cooling set point+1)
G_001 Office	0.1	99.8	0.1
G_002 Office	0.1	99.7	0.2
G_003 Office	0.0	99.9	0.1
G_004 Office	0.0	99.9	0.1
G_005 Office	0.1	99.7	0.2
G_Changing	0.3	99.6	0.1
G_Reception	0.0	99.9	0.1
G_Security	0.4	99.5	0.1

How can simulation be improved?

PV - exported energy

- Exported energy needs to be excluded.
- Carry out hourly comparison of rated energy and generated energy.
- Likely to affect buildings with large PV arrays and low base loads.

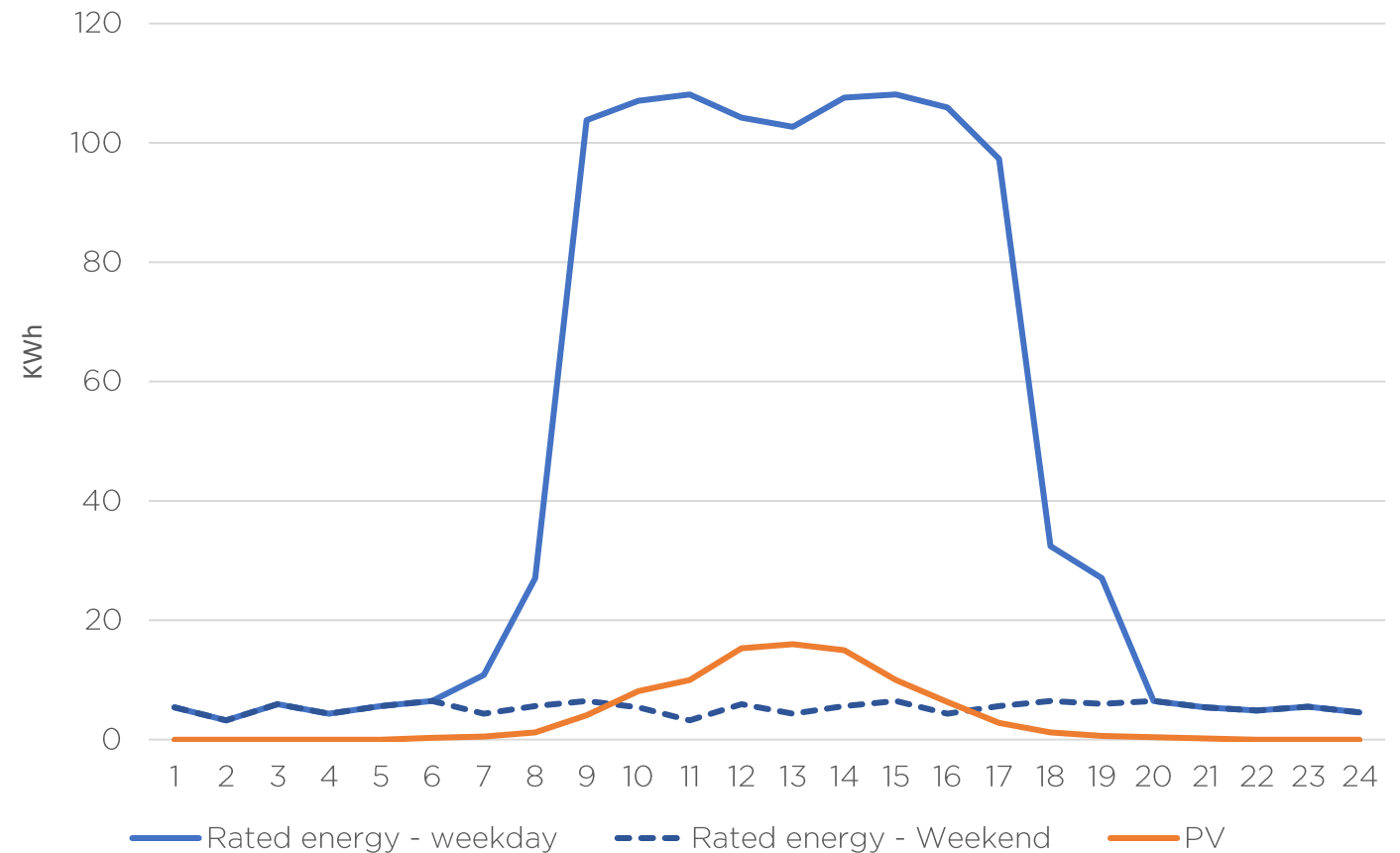

How can simulation be improved?

Off-axis scenarios

- Choice will depend on the particular building.
- Need to have a substantial effect on the rating.
- Report needs to fully define the inputs.
- Commonly required off-axis scenarios:
 - AHU/ extract fans running outside occupancy hours.
 - CO₂ sensor failure.
 - Tighter heating and cooling setpoints.
 - Heat recovery failure.
 - Control failures.
 - Metering failures.

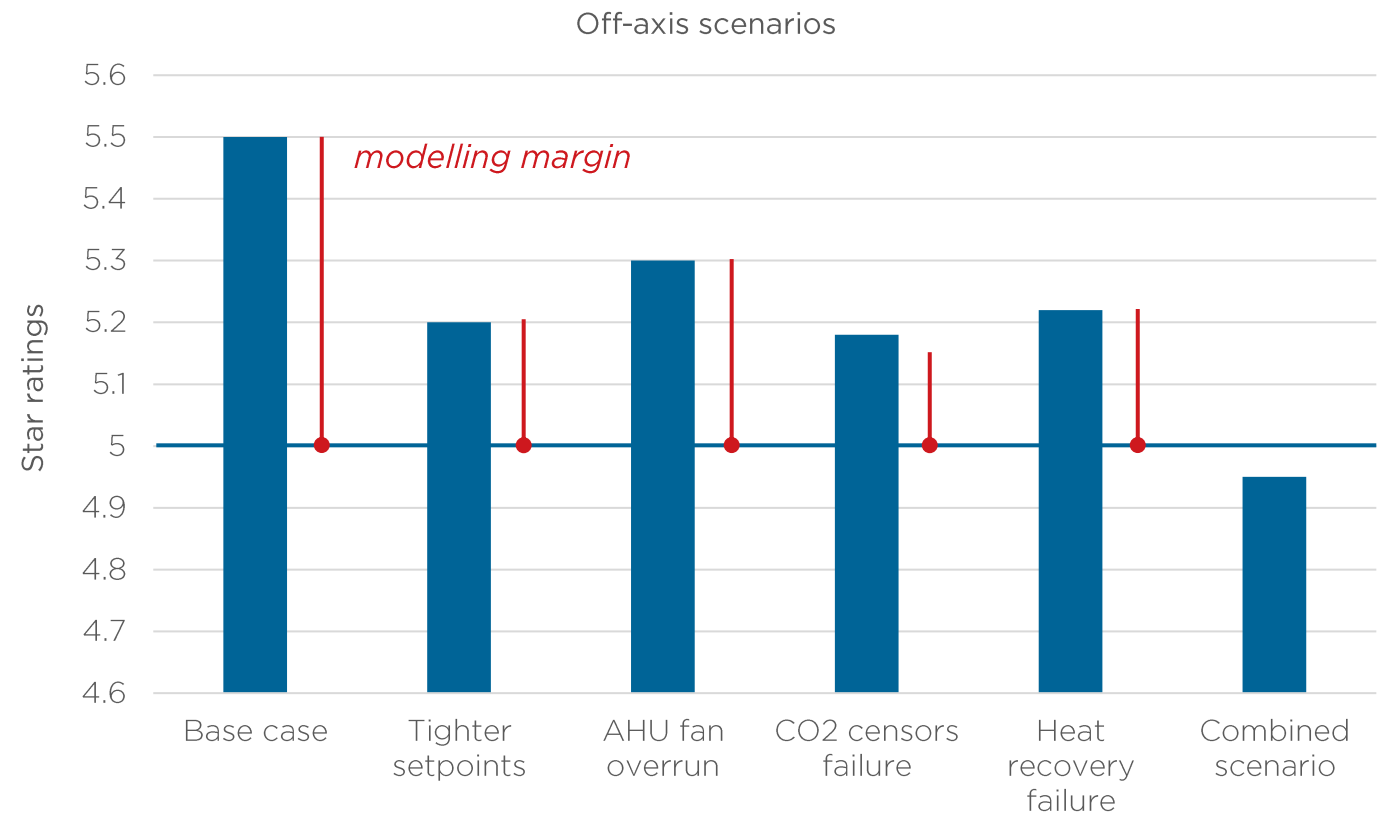

How can simulation be improved?

Controls

Specify control scenarios used in model:

- Turndowns.
- Setpoints.
- Ramp or step functions.

e.g., for CO₂ volume control, lighting control, supply air temperature.

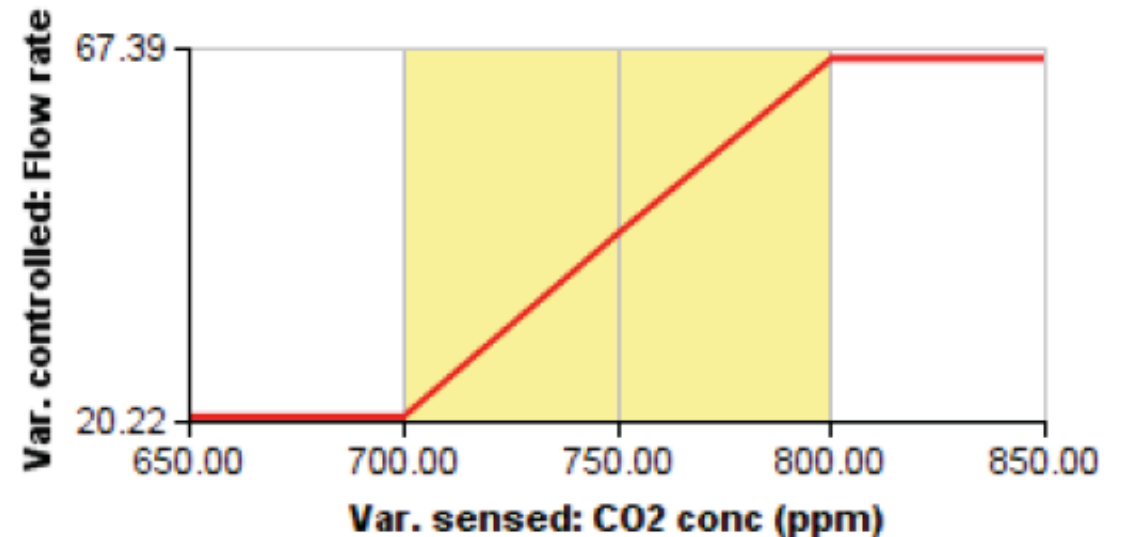

Variation of fresh air flow rate with CO₂ concentration

How can simulation be improved?

Other loads

Include and fully define in report, e.g.:

- Loads in landlord areas.
- Basement/plant ventilation (sometimes intended to be at high volumes 24/7).
- Cycle store ventilation.
- Changing room loads.
- Auxiliary loads (such as misc. pumps or security system power).
- Trace heating.
- Switchboard & reticulation losses.



Closing Remarks and Scheme Updates

Closing Remarks and Scheme Updates

Scheme Update

- NABERS UK is governed by the NABERS Scheme which is owned by Australia's New South Wales Government.
- BRE has chosen to terminate its agreement to administer the UK scheme for NABERS.
 - The BRE have committed to continuing to support NABERS UK until a new administrator is appointed.
 - With the NABERS UK rules governed by NABERS and the wider steering group, no changes to rules are expected as part of this transition.
- NABERS UK is expected to continue to grow to cover other building types, which are already covered by the Australian scheme.

Closing Remarks and Scheme Updates

Training for DfP

Training available for undertaking Advanced Simulation Modelling for Design for Performance through CIBSE Training.

- Course developed by Delta Q, Verco & BPL, funded by CIBSE.
- Training currently provided by Darren Coppins.
- Search for Design for Performance on the CIBSE Training website.

Advanced Simulation Modelling for Design for Performance

6.0

CPD Hours

Standard Rate: **£390.00 +VAT**

Member Rate: **£310.00 +VAT**

 Digital Engineering

Course Overview

[Who Should Attend](#)

[Agenda](#)

[Joining Instructions](#)

[How to Book](#)

[Assessment](#)

[Trainer](#)

[Terms and Conditions](#)

This course is delivered as either:

- Face-to-face: One day course (10:00am to 4:00pm)

Or

- Remote: Three half-days course, mornings (10:00am to 12:00pm)

Advanced Simulation Modelling for Design for Performance is aimed at upskilling the Mechanical, Electrical and Plumbing community in the theoretical approach to simulation modelling when targeting an operational energy rating. The course will cover the following points:

- An introduction to the NABERS UK rating tool and Design for Performance Project Agreements
- An overview of the Guide to Design for Performance
- The role of advanced simulation in targeting operational performance ratings
- Principles in approach for modelling:
 - Building form
 - HVAC plant and systems: covering HVAC design, system control and system loads
 - Lighting
 - Equipment loads
 - Margins of error
 - Off-axis scenario analysis that demonstrate the resilience of building design
 - Metering specification



Q&A

**Claire
Das Bhaumik**

Partner
Inkling LLP



**Darren
Coppins**

Director
Built Physics Limited



**Hugh
Gordon**

Associate
Hilson Moran



**Owen
Boswell**

Senior /Associate
Hoare Lea

